

# RECLAMATION

*Managing Water in the West*

## Rock Ramp Design Guidelines 2<sup>nd</sup> Edition

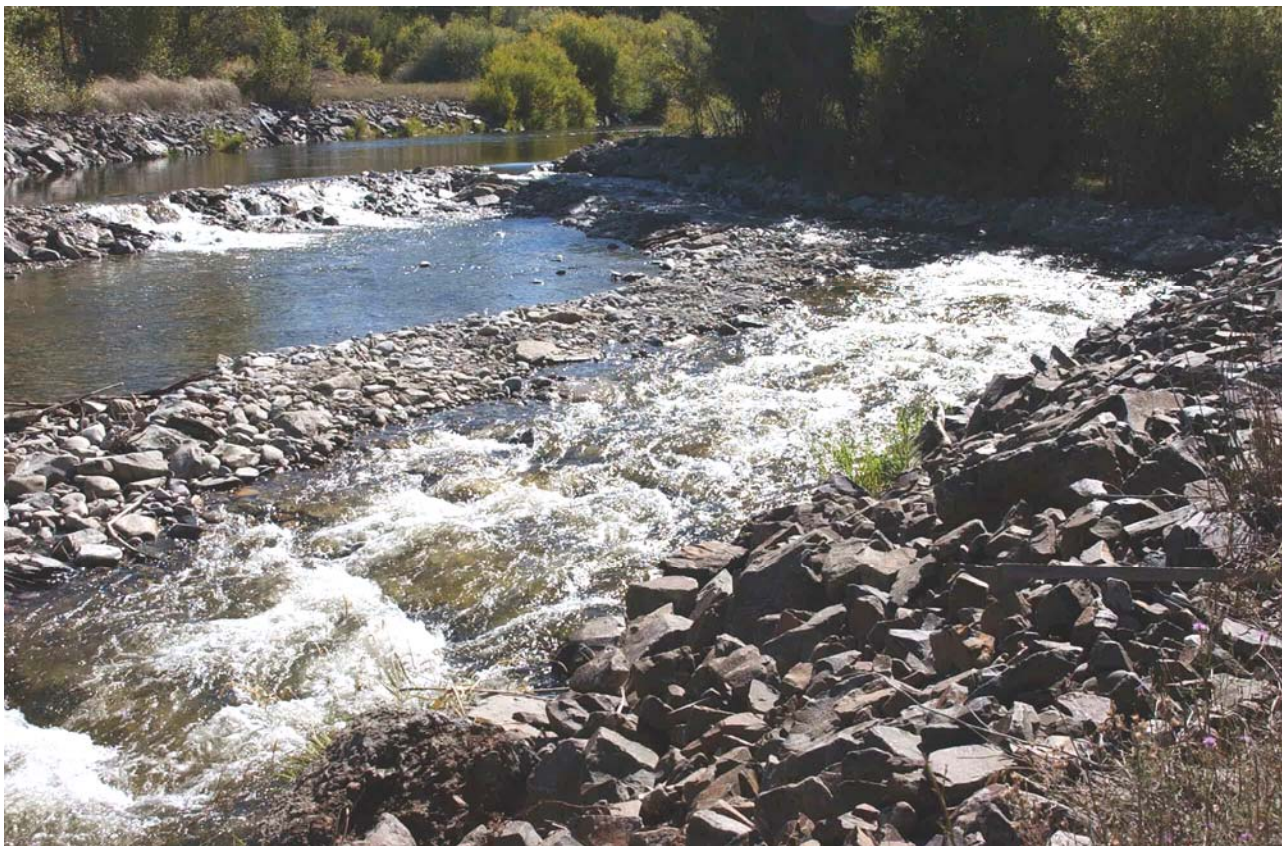

U.S. Department of the Interior  
Bureau of Reclamation  
Technical Service Center  
Denver, Colorado

August 2019

## **Mission Statements**

The mission of the Department of the Interior is to protect and provide access to our Nation's natural and cultural heritage and honor our trust responsibilities to Indian Tribes and our commitments to island communities.

The mission of the Bureau of Reclamation is to manage, develop, and protect water and related resources in an environmentally and economically sound manner in the interest of the American public.

# Rock Ramp Design Guidelines

*prepared by*

**David M. Mooney, MS**

Hydraulic Engineer  
Sedimentation and River Hydraulics Group  
Technical Service Center, Denver, CO

**Chris L. Holmquist-Johnson, MS**

Hydraulic Engineer  
Sedimentation and River Hydraulics Group  
Technical Service Center, Denver, CO

**Susan Broderick**

Fisheries Biologist Technical Service  
Center, Denver, CO

*reviewed by*

**Kent L. Collins, PE**

Hydraulic Engineer  
Sedimentation and River Hydraulics Group  
Technical Service Center, Denver, CO

**Tim Randle, PE, PhD**

Hydraulic Engineer  
Sedimentation and River Hydraulics Group  
Technical Service Center  
Denver, CO

*Additional reviewers include*

**Toni Turner, P.E.**

Hydraulic Engineer  
Pacific Northwest Regional Office  
Design Group  
Boise, ID

Original version of guidelines was produced in 2007.



# Contents

	Page
<b>1.0 Introduction.....</b>	<b>1</b>
1.1 Failure Mechanism Approach.....	1
1.2 Report Structure.....	2
<b>2.0 Local and System Interactions with Rock Ramps .....</b>	<b>5</b>
<b>3.0 Rock Ramp Geometry and Hydraulics.....</b>	<b>7</b>
3.1 Overview.....	7
3.2 Roughness.....	9
3.2.1 Depth Independent Roughness for Mild Gradients .....	11
3.2.2 Depth Based Roughness .....	11
3.2.3 Steep Slope Roughness Estimation (Rice et al. 1998).....	12
3.2.4 Evaluation of Roughness Relationships.....	13
3.2.5 Roughness Prediction Recommendations.....	15
3.2.6 Additional Energy Loss .....	15
3.3 Interstitial Flow Velocity .....	16
3.4 Low Flow Normal Depth Hydraulics .....	17
3.5 High Flow Conveyance Geometry.....	20
3.6 High Flow Backwater Modeling (Riprap Design).....	21
3.7 Rock Ramp Geometry Design Procedure.....	21
3.8 Summary.....	22
3.9 References.....	22
<b>4.0 Riprap Sizing.....</b>	<b>25</b>
4.1 Overview.....	25
4.2 Hydraulics.....	26
4.3 Embankment Overtopping (Bed) Riprap Sizing Relationships .....	27
4.3.1 Abt and Johnson (1991).....	28
4.3.2 Ullmann (2000).....	29
4.3.3 Ferro (1999).....	30
4.3.4 Robinson et al. (1998).....	30
4.3.5 USACE (1991) Bed .....	31
4.3.6 Whittaker and Jäggi (1986).....	31
4.3.7 Equations Investigated but Not Recommended .....	32
4.4 Side Slope Riprap Sizing Relationships .....	34
4.4.1 Individual Stone Stability .....	34
4.4.2 USACE (1991) Side Slope.....	35
4.5 Riprap Layer Thickness .....	36
4.6 Riprap Gradation.....	36
4.7 Riprap Filter Criteria.....	37
4.8 Upstream Cutoff Wall.....	38
4.9 Downstream Transition.....	38
4.10 Construction Concerns.....	38
4.11 Summary.....	39
4.12 References.....	39

<b>5.0</b>	<b>Fish Swimming Capabilities and Passage Criteria .....</b>	<b>41</b>
5.1	Introduction.....	41
5.2	Swim Speeds for Anadromous Fish.....	41
5.3	Agency Fish Passage Criteria for Depth, Pool Spacing, and Velocity.....	43
5.4	Fish Passage Guidelines for Culverts .....	43
5.5	Rock Weirs, Boulder Clusters, and Nature-Like Fishways .....	43
5.6	The Planning Process.....	45
5.7	References.....	46
<b>6.0</b>	<b>Design Event and Lifecycle Costs.....</b>	<b>49</b>
6.1	Overview.....	49
6.2	Probability of Failure or Maintenance Requirements.....	49
6.3	Costs of Replacement and Maintenance .....	52
6.4	Total Lifecycle Costs .....	53
6.5	Lifecycle Cost Estimation Steps .....	56
6.6	Summary .....	57
<b>7.0</b>	<b>Boulder Clusters and Isolated Rocks .....</b>	<b>59</b>
7.1	Overview.....	59
7.2	Range of Applicability.....	60
7.3	Shape and Sizing of Isolated Rocks.....	62
7.4	Planform Placement of Isolated Rocks.....	64
7.4.1	Morphologic Location .....	64
7.4.2	Intra-cluster Configuration and Interstitial Spacing .....	64
7.4.3	Flow Obstruction .....	65
7.4.4	Longitudinal Spacing.....	66
7.4.5	Lateral Location .....	66
7.5	Hydraulic Impacts.....	67
7.5.1	Isolated Rock Simulation through Added Roughness .....	67
7.5.2	Isolated Rock Simulation via Bridge Pier Techniques .....	67
7.5.3	Local Flow Characteristics .....	67
7.6	Embedded Depth and Scour.....	67
7.6.1	Recommended Values .....	68
7.6.2	Boulder Specific Testing.....	68
7.6.3	Clear Water Pier Scour .....	69
7.7	Impact on Rock Ramps.....	70
7.8	Design Steps.....	70
7.9	Design Example .....	70
7.10	References.....	73
<b>8.0</b>	<b>Constructed Step-Pools .....</b>	<b>75</b>
8.1	Overview.....	75
8.2	Range of applicability.....	76
8.3	Step-Pool Characteristics .....	77
8.3.1	Step Height.....	77
8.3.2	Step-Pool Frequency.....	78
8.3.3	Step Rock Size .....	79
8.4	Hydraulics.....	79
8.5	Estimating Scour Hole Depth .....	80

8.5.1	Recommended Values .....	81
8.6	Step –Pool Design.....	83
8.7	References.....	84
<b>9.0</b>	<b>Conclusions and Future Work.....</b>	<b>85</b>
9.1	Conclusions.....	85
9.2	Future Work.....	85
<b>10.0</b>	<b>Rock Ramp Design Example.....</b>	<b>87</b>
10.1	Overview.....	87
10.2	Low Flow Design Discharge .....	87
10.3	Initial Riprap Diameter and Roughness Estimate.....	88
10.4	Interstitial Flow Velocity .....	88
10.5	Low Flow Channel Geometry.....	90
10.6	High Flow Design Discharges .....	93
10.7	High Flow Channel Geometry .....	94
10.8	Riprap Design Flows.....	97
10.9	Bed Material Riprap Sizing .....	98
10.9.1	Abt and Johnson (1991).....	99
10.9.2	Robinson et al. (1998).....	99
10.9.3	Ferro (1999) .....	99
10.9.4	USACE (1991) Bed .....	100
10.9.5	Whittaker and Jäggi (1986).....	101
10.10	Bank Material Riprap Sizing .....	102

## **Acknowledgments**

Funding was provided by the Pacific Northwest Regional Design Group. Thanks to Toni Turner of the PN Design group for providing comments on the initial draft. Drew Baird served as a client liaison for initiating this project.



# 1.0 Introduction

Rock ramps or roughened channels consist of steep reaches stabilized by large immobile material (riprap). Primary objectives for rock ramps include:

- Create adequate head for diversion
- Maintain fish passage during low-flow conditions
- Maintain hydraulic conveyance during high-flow conditions

Secondary objectives for rock ramp design include:

- Emulate natural systems
- Minimize costs

The rock ramp consists of a low-flow channel designed to maintain biologically adequate depth and velocity conditions during periods of small discharges. The remainder of the ramp is designed to withstand and pass large flows with minimal structural damage. The following chapters outline a process for designing rock ramps.

## 1.1 Failure Mechanism Approach

The strategy for developing design guidelines addresses potential failure mechanisms and either directly avoids failure mechanisms or incorporates counter-measures. Failure mechanisms include performance as well as damage to the structure.

System considerations consist of geomorphic factors which may impair a structure and require looking beyond the specific site to identify watershed factors. System impacts include:

- Headcuts: downstream areas of high sediment transport can cause river bed degradation and undermining of structures without proper protection.
- Channel Migration: Shifts in the channel alignment can render a structure inoperable. Rock ramps should be constructed on controlled straight reaches rather than at meander bends, which could result in point bar deposition on top of the rock ramp.
- Sediment Storage: systems with high sediment loads may cause deposition behind a rock ramp sill. Deposition can result in upstream flooding or diversion maintenance requirements. The increase in river stage would be primarily caused by the rock sill.

Biological performance criteria consist of meeting regulatory or site specific habitat and passage requirements. Biological performance criteria may include:

- Low Flow Depth: minimum depth required for fish passage.

- **Low Flow Velocities:** maximum velocity permitted for fish passage. The velocity may depend on the rock ramp length.
- **Swim Distance:** maximum distance a fish can swim at a given velocity.
- **Step Height:** maximum jump height a fish can cross for structures within a rock ramp. Height may depend on the depth of the downstream pool.

Structural considerations consist of designing a structure to withstand large flows. Failure of the structure may occur through:

- **Rolling or Sliding of the Riprap Material:** hydraulic entrainment or overturning may damage the structure if the rock material is undersized.
- **Undermining through Piping:** piping of fine material from under the structure to a head differential may cause undermining and fail a structure.

The design approach provides a means for understanding the likely robustness of structure and balancing rare maintenance of more costly structures with more frequent repair of cheaper structures. In some cases, a rock ramp alone may be unlikely to accomplish all project objectives. The addition of features such as boulder clusters and/or step pools may assist in creating the best performance.

## 1.2 Report Structure

The rock ramp design guidelines begin with a design procedure and methods for a simple roughened channel. Later chapters describe additional features to improve the biological characteristics. The last chapter provides example calculations for a hypothetical design. The guidelines consist of the following sections:

- **Chapter 2 – Local and System Interactions** overviews how the rock ramp changes the surrounding river channel and landscape and how river and landscape concerns may impact rock ramp design.
- **Chapter 3 – Ramp Geometry and Hydraulics** describes procedures for designing and modeling flow over rock ramps during high flow storm events and low-flow conditions.
- **Chapter 4 – Riprap Design** provides methods for sizing and specifying the stone used to form a stable structure including entrance and exit transitions.
- **Chapter 5 – Fish Passage Criteria** summarizes current research into fish swimming capabilities.
- **Chapter 6 – Design Event and Lifecycle Costs** provides methods for determining the appropriate design event to minimize total costs.
- **Chapter 7 – Boulder Clusters** reviews literature for the sizing and placement of large rocks to provide depth and velocity diversity.

- **Chapter 8 – Step Pools** reviews literature for the sizing, placement, and design of step pool structures for fish passage.
- **Chapter 9 – Conclusions and Future Work** provides a summary of the design process and ideas for future improvement.
- **Chapter 10 – Basic Design Example** steps through the calculation procedures for the different methods using a hypothetical example based on numbers from the Methow Basin, WA.

Each chapter contains a list of the references specific to the material covered. Design procedures from different chapters may require an iterative process to evaluate the impact of different features on the basic design.

The second edition of the guideline was produced to correct an error in Eq. 4-2.



## 2.0 Local and System Interactions with Rock Ramps

Rivers behave as dynamic interrelated systems with long and short term changes occurring on local and widely distributed spatial scales. These changes can alter the original design parameters and fail a structure. Understanding the likely direction of change improves chances for success. Evaluation of system effects is beyond the scope of these rock ramp guidelines but requires investigation. System impacts include:

- Degradation
  - Local decrease in sediment supply such as downstream of a dam
  - Downstream base level lowering from basin wide reductions in sediment load
- Aggradation
  - Increase in sediment supply such as from changes in land use or debris flows
  - Decreases in transport capacity such as from base level rising
- Channel Migration
  - At some rate, river bends move laterally as well as translate downstream
  - Altering meander dynamics is typically costly and the resulting series of geomorphic changes is difficult to predict and frequently undesirable.
  - River migration may cause local flanking of a structure.
  - A meander bend at a rock ramp may result in point bar deposition along the inside of a bend and on top of the ramp.
  - Structures can impede or accelerate migration processes.
- Construction Disturbances
- Geomorphic Thresholds
  - Changes to rivers may result in abrupt shifts in planform and change the performance of a structure.
  - Destruction of armor layer can initiate down-cutting and headcut migration.

The absence of system interactions in the design guidelines should not be construed to imply a lack of significance as the system effects can easily alter

## Rock Ramp Design Guidelines

local conditions. Limitations on the scope of this project require that designers investigate the context of dynamic systems from sources outside this manual.

## 3.0 Rock Ramp Geometry and Hydraulics

### 3.1 Overview

The two basic ramp configurations evaluated include the channel spanning ramp and the partial spanning ramp. The channel spanning rock ramp cross section shape consists of a high flow channel from bank to bank with a low flow notch as shown in Figure 3-1.

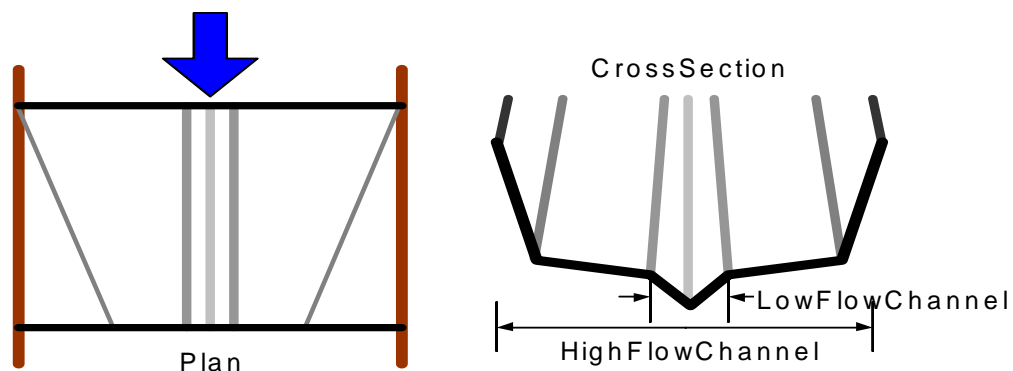

(a)

(b)

**Figure 3-1 Channel Spanning Rock Ramp: a) plan view of a ramp with a channel bottom that decreases in width in the downstream direction, and b) isometric view showing the transverse bottom slope and low flow notch.**

The steeper, narrow width of the notch in Figure 3-1 increase water depth in the small central region of the channel to provide fish passage during low flow periods.

A partial span rock ramp configuration consists of a rock ramp bypass where a low flow channel is constructed adjacent to and around a sill as shown in Figure 3-2.

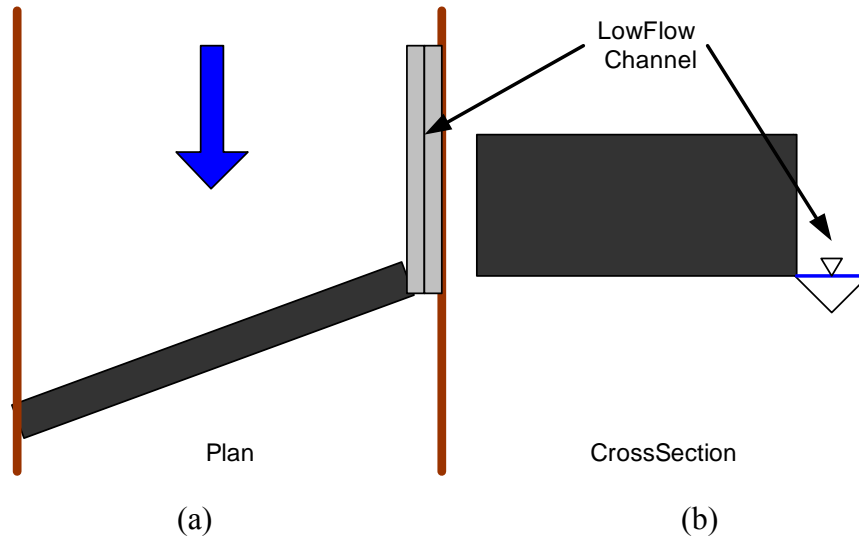

**Figure 3-2 Partial Spanning Rock Ramp (Bypass): a) plan view showing the rock ramp on river left upstream of the structure, and b) cross section (upstream view) showing the sill and the bypass rock ramp.**

The planform angle of the sill forces the channel thalweg (deeper portion of the river) towards the bank with the rock ramp. In lower flows, the angle will also guide fish into the ramp as they swim upstream. Placing the ramp upstream of the sill prevents stagnant pools that can confuse and trap fish but this configuration may require modification of the sill structure to create a notch. This configuration can increase the shear stress on the ramp during high flows by raising the depth. The ramp can also be placed on the downstream side, but fish may not readily locate the fish bypass.

Ramp hydraulics depend on the geometry of the ramp, the flow rate, and the roughness of the material used to construct the ramp. To begin a design, several variables need to be identified, including:

- Upstream water surface elevation: If the ramp is designed for an irrigation diversion, the upstream water surface elevation is governed by the elevation head required to meet that diversion. If the ramp is being designed for fish migration through a culvert with an invert higher than the nearby river water surface elevation, the upstream water surface elevation would depend on the culvert invert elevation.
- Downstream water surface elevation and/or downstream channel bed topography.
- Low Flow Design Discharge: governed by water availability;
- High Flow Design Discharge; governed by flow frequency, stake holder, and economic considerations (the peak flow, design life and economics are included in Chapter 6).
- Roughness of the Ramp: governed by rock material size and construction technique.
- Side Slope of the High Flow Channel: governed by local topography, land owner considerations, material and construction methods.



- Minimum depth, maximum velocity, and maximum slope criteria from applicable stake holder or regulatory agencies. These variables are sometimes reported from laboratory measurements of swim speed, dart speed, and endurance testing in velocity chambers.
- Space: project sites have a limited area for implementing structures.

Within these considerations, and using flow hydraulics, the ramp geometry can be determined, including:

- Slope or Length of the Ramp;
- Bottom Width;
- Bottom Transverse Slope: creates a low flow channel that may be narrower than the ramp bottom width; and
- Side Slope of the Low-Flow Channel: if a compound channel section is designed.

The selection of a length, width, side slope, and whether the ramp bottom has a transverse slope or is flat will impact the hydraulic and sediment transport performance. Key fish passage parameters include the flow depth and velocity. Key sediment transport hydraulic parameters include stream power (which is a function of the flow, slope, and the density of the fluid) as well as velocity. The acceptable depth of flow and velocity through the range of discharges is determined by Natural Resource Regulatory Agencies or fish swim speed and dart speed. The length of rock ramps can also be determined from data on the length of time a particular species can sustain a normal swim speed.

The geometry and hydraulics of the rock ramp are related to the size of the riprap and vice versa. To design the ramp, multiple iterations are required until the design goals are met. During low-flow conditions a minimum depth of flow may be required to pass fish at the entrance to the ramp, through the ramp, and at the outlet from the ramp. During low flows, downstream effects are less likely to exert backwater effects. Low-flow hydraulics can be estimated using normal depth calculations to determine the channel cross section that provides the minimum depth for fish passage (see section 3.4). Analysis of flood flow conditions is best accomplished using a backwater hydraulic model such as HEC-RAS (Brunner 2002), which can also estimate entrance and exit hydraulics for both low and high flow conditions.

## 3.2 Roughness

Roughness is used to describe energy loss due to hydraulic interaction with the grain roughness in the surrounding channel boundaries. The roughness impacts the depth and velocity of flow. On rock ramps with geometry similar to those shown in Figure 3-1 and Figure 3-2, loss occurs primarily through friction due to grain roughness. Additional features in a ramp such as obstructions or steps will add additional roughness.

Several different methods of determining roughness are presenting in the following section. A Manning's  $n$  roughness or Darcy-Weisbach friction factor is used to represent the energy loss due to roughness. In the Darcy-Weisbach method, the influence of grain roughness varies with flow depth and requires an iterative procedure. High-flow and low-flow analyses would use different values. Most open channel hydraulic applications in the U.S. simplify the relationship and assume losses due to friction are independent of flow depth. The majority of Manning's  $n$  roughness values originates from empirical studies and applies to mild gradient streams (Section 3.2.1). More general based methods are presented in section 3.2.2. Abt et al. (1987) and Rice et al. (1998) conducted research to determine Manning's  $n$  values for steep channels. The equation developed by Rice et al. is recommended and includes the work by Abt et al. (see section 3.2.3) Literature review did not identify quantitative results on the influence of gradation on roughness.

During low flow, rock ramps will likely consist of rocks with diameters nearly as large as the flow depth with some protruding into the flow. Figure 3-3 shows a cross section of flow through a ramp and the roughness created by riprap.

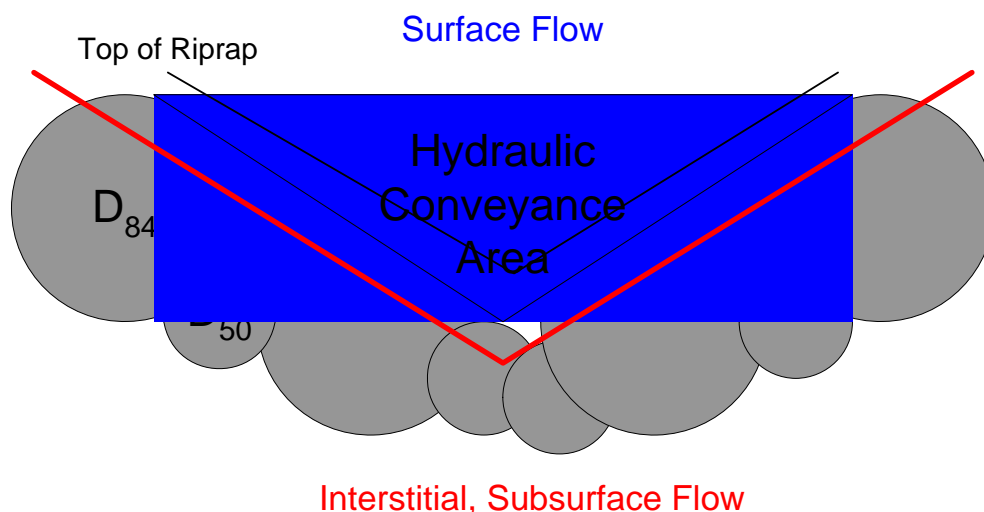

**Figure 3-3 Rock Ramp Low Flow Channel Flow Conveyance Area**

In a typical riprap gradation the median diameter,  $D_{50}$  is approximately one-half of the largest diameters (represented by the  $D_{84}$ ) in Figure 3-3. Part of the water flows through the interstitial space of the riprap layer as subsurface flow whereas surface flow consists of water visible above the rock material. The hydraulic parameters of wetted perimeter, conveyance area, and flow depth represent a straight line through the centroids of the surface riprap voids. The roughness accounts for skin friction and the twisting and turning of flow through the area between the interstitial flow and the top of the riprap layer. On a site specific basis, if the protrusion of a rock into the flow area is significant, it may warrant reducing the flow conveyance area to account for the blocked area. However, most of the time, the roughness analysis can assume the rocks on the ramp have been packed after placement to smooth irregularities, and would not require blocked areas be included in the analysis.

### 3.2.1 Depth Independent Roughness for Mild Gradients

Richardson, et al. (2001) summarize several relationships relating roughness to grain diameter in the form of Equation 3-1.

$$n = K_u \cdot D_x^{1/6} \quad \text{Equation 3-1}$$

Where,

$n$  = channel roughness;

$K_u$  = dimensional coefficient; and

$D_x$  = representative grain diameter.

Values for coefficient,  $K_u$ , and the selection of a grain diameter,  $D_x$ , depend on the specific roughness relationship. The equation is dimensional. Table 3-1 shows the computation matrix for various studies.

**Table 3-1 Roughness Coefficients and Representative Diameters**

Author	Metric Coefficient, $K_u$ ( $D_x$ in Meters)	US Customary Coefficient, $K_u$ ( $D_x$ in Feet)	Representative Diameter, $D_x$ (m or ft)
Henderson (1966)	0.038		$D_{75}$
Lane and Carlson (1955)	0.0473	0.0388	$D_{75}$
Strickler (1923)	0.041		$D_{50}$
U.S. Army Corps (1991)	0.046	0.038	$D_{90}$

The different relationships require different representative grain diameters, shown in the fourth column of Table 3-1. Use of the wrong diameter will create an erroneous roughness value. Sensitivity is reported in section 3.2.3. The roughness relationships were developed for milder slopes and smaller grain diameters than likely to be present on rock ramps.

### 3.2.2 Depth Based Roughness

The most theoretically rigorous evaluation of roughness involves the Darcy-Weisbach friction factor that computes roughness as a function of the flow depth and the protrusion of elements into the flow. Equation 3-2 and Equation 3-3 show the flow resistance relationships.

$$\frac{1}{\sqrt{f}} = -2.0 \cdot \log_{10} \left( \frac{k_s}{3.71 \cdot D} + \frac{2.51}{\text{Re} \cdot \sqrt{f}} \right) \quad \text{Equation 3-2}$$

$$\text{Re} = \frac{V \cdot D}{\nu} \quad \text{Equation 3-3}$$

Where,

$f$  = Darcy-Weisbach friction factor;

$k_s$  = height of a roughness element;

$D$  = hydraulic depth;

$Re$  = Reynolds number;  
 $v$  = average velocity; and  
 $\nu$  = kinematic viscosity.

The height of a roughness element depends on the grain diameter with many different estimation techniques that account for different flow aspects. For the rock ramp, the representative height will assume that the  $D_{50}$  diameter protrudes half way into the flow. Roughness elements should use a  $k_s$  value equal to the  $0.5 * D_{50}$  as qualitatively shown in Figure 3-3. Designers should consider construction techniques and riprap material and modify the  $k_s$  factor if the ramp suggests a different amount of protrusion. Hydraulic references for rivers may use different factors of  $k_s$ . These empirical relationships can account for other features present in natural systems such as bed forms and macro-forms. When the background of the  $k_s$  factor is unknown, using the 0.5 factor results in a shallower water depths and faster velocities.

Using the Darcy-Weisbach relationship to determine roughness requires an iterative procedure to solve to the friction factor. Rock ramp calculations should result in friction factors within the range of boulder bed streams. Julien (2002) reports boulder bed friction factor ranges from 0.029-0.076.

The Manning roughness coefficient can be related to the Darcy-Weisbach friction factor according to Equation 3-4.

$$n = R^{1/6} \cdot \sqrt{\frac{f}{8 \cdot g}} \quad \text{Equation 3-4}$$

Where,

$n$  = Manning roughness coefficient;  
 $R$  = hydraulic radius;  
 $f$  = Darcy-Weisbach friction factor; and  
 $g$  = acceleration due to gravity.

The roughness factor will require an additional iteration depending on changes in the riprap dimensions.

### 3.2.3 Steep Slope Roughness Estimation (Rice et al. 1998)

Rice et al. (1998) performed roughness testing and found good agreement with testing reported by Abt et al. (1987). Rice et al. combined the Abt et al. data sets with their testing data to develop Equation 3-5 for roughness.

$$n = 0.029 \cdot (D_{50} \cdot S_0)^{0.147} \quad \text{Equation 3-5}$$

Where,

$n$  = Manning's n-value;  
 $D_{50}$  = median grain diameter of the riprap (mm); and  
 $S_0$  = slope of the rock ramp.

Abt et al. (1987) tested angular shaped riprap with  $D_{50}$  diameters from 26 to 157 mm at slopes from 0.01 to 0.20. Rice et al. (1998) tested a 188 mm  $D_{50}$  on a 0.167 slope and a 278 mm  $D_{50}$  on a 0.333 slope. The total testing scope includes diameters from 26 mm to 278 mm (0.085 to 0.91 ft) and relative roughnesses with the  $D_{84}$  equal to twice the flow depth. The Rice (1998) method is recommended for rock ramp design. Julien (2002) reports typical boulder bed stream n-values ranging from 0.25-0.04.

### 3.2.4 Evaluation of Roughness Relationships

Different roughness estimation techniques provide different answers. A comparison of the different techniques provides a means to identify the sensitivity of results to the chosen technique and input values.

Roughness estimating relationships use different representative grain diameters as input. To compare the difference relationships, the median diameter,  $D_{50}$ , was used based on the gradation recommended by Simons and Sentürk (1992). Simons and Sentürk recommend a smooth semi-log gradation curve where the maximum diameter,  $D_{100}$ , is approximately twice the median diameter,  $D_{50}$ , and the diameter larger than 20% of the mass,  $D_{20}$ , is approximately half the  $D_{50}$  (see section 4.5). For the methods in Table 3-1, Figure 3-4 shows roughness values as a function of median riprap grain diameter,  $D_{50}$ .

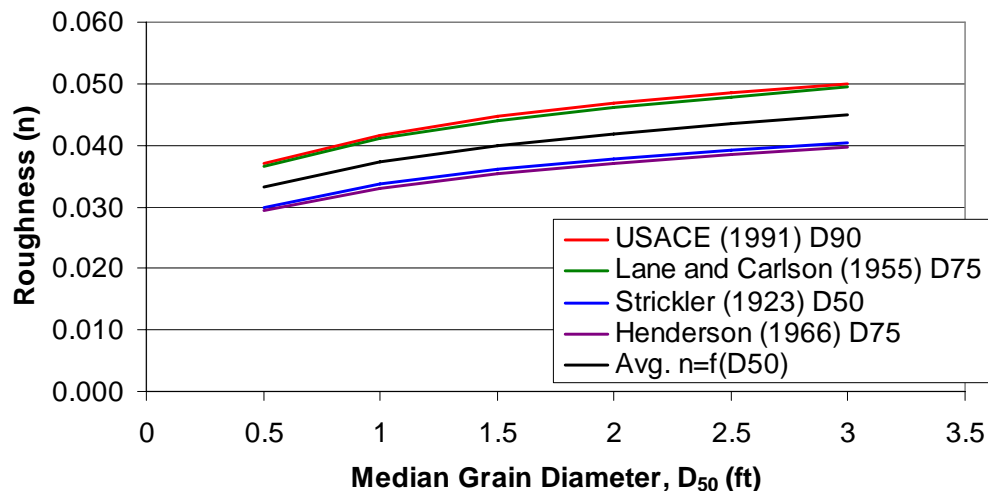

**Figure 3-4 Depth Independent Roughness as a function of Median Grain Diameter**

As an example of the sensitivity of the roughness “n” upon channel hydraulics, a wide rectangular channel (hydraulic depth is very close to the hydraulic radius) will be used. If estimates of roughness for a 1.0 ft  $D_{50}$  vary from an n-value of 0.033 to 0.042, the depth increases by 16% and the velocity decreases by 21%.

The hydraulics for sizing riprap to resist failure during large discharges also depends on roughness. Required riprap median size is roughly proportional to the square root of velocity. A 21% change in velocity could impact riprap diameters by 4.5%. The depth based relationships are more difficult to compare, but yield a similar range of values. In most cases, the final rock diameter is rounded up to

meet quarry availability. The rounding is likely greater than the potential 4.5% difference in riprap diameter.

The method of Rice et al. varies roughness as function of slope as well as the median diameter. Figure 3-5 shows the combination of slope and median diameters and includes the average roughness values from Figure 3-4.

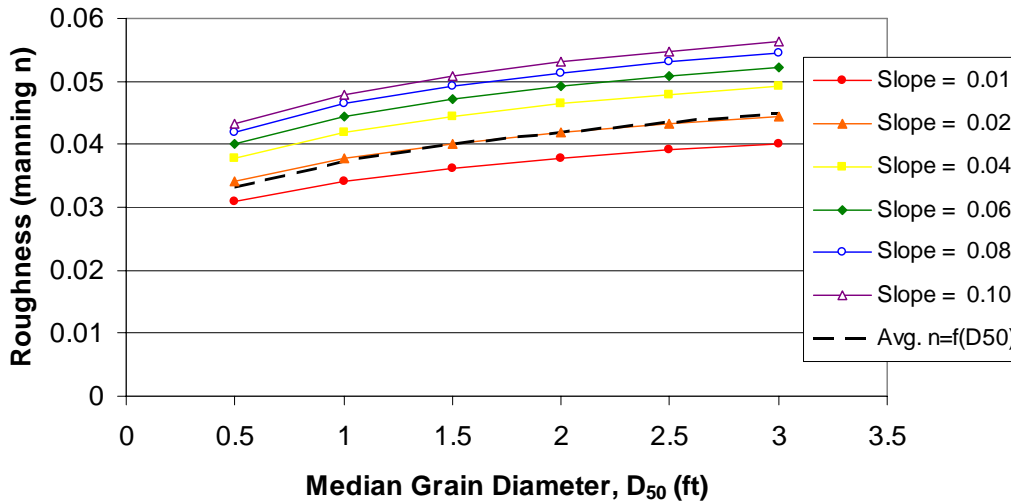
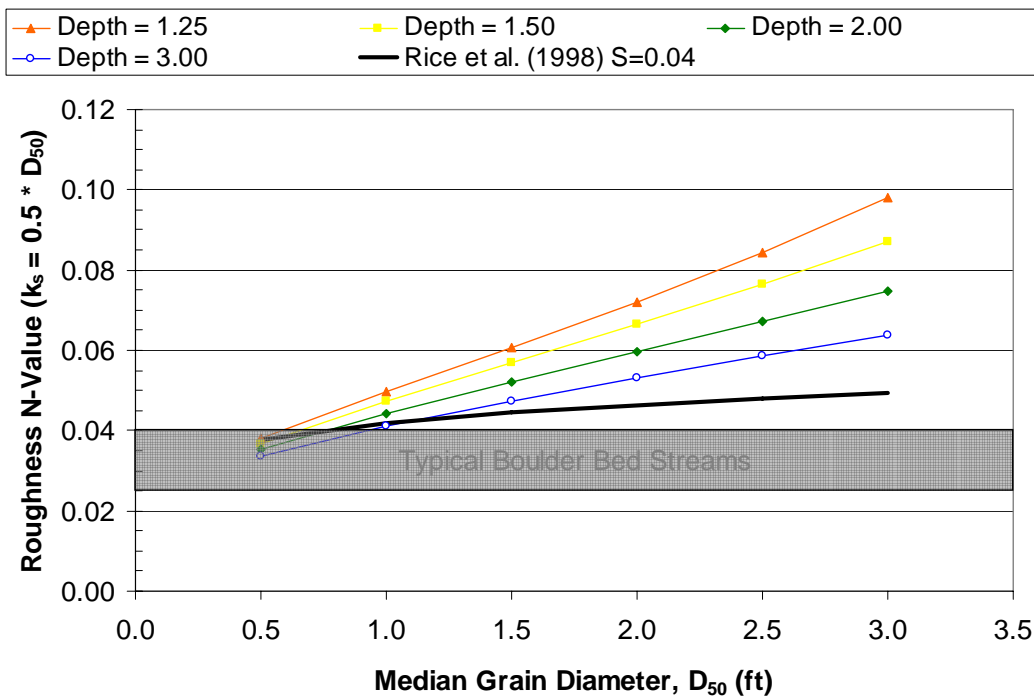

Figure 3-5 Rice et al. Roughness as a Function of Mean Grain Diameter and Slope

Mild slope relationships tend to under-predict roughness for rock ramps. The empirical source of the Rice et al. relationship incorporates some aspects of flow depth through the slope term. Figure 3-6 shows depth-based prediction using the Darcy-Weisbach method for a rectangular ramp sloped at 0.04.



**Figure 3-6 Depth-Based Roughness as a Function of Depth and Median Grain Diameter for a Slope of 0.04**

Rice et al. tested roughness for high relative depths and may under-predict roughness in low flow channels with shallow relative depths. Shallower depths increase the influence of a roughness element protruding into the flow. Figure 3-7 shows the influence of the relative protrusion on the roughness estimate for a rectangular ramp with a slope of 0.04.

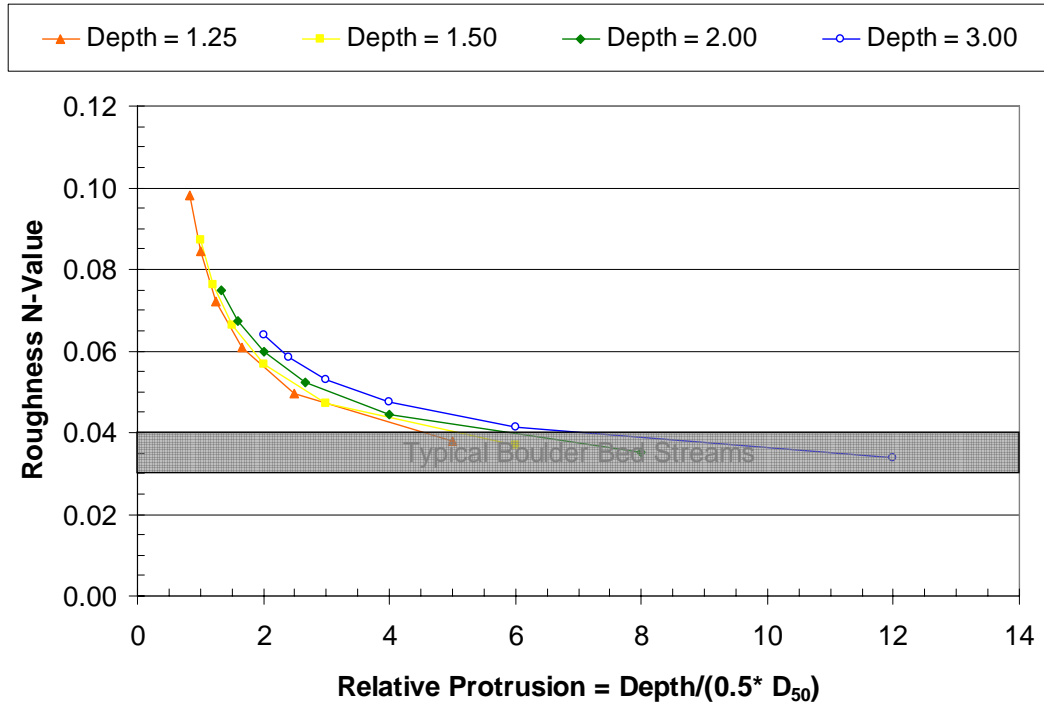

**Figure 3-7 Roughness as a Function of Relative Protrusion for a Slope of 0.04 ft/ft**

When flow depths are on the order of the roughness height, the roughness is very sensitive to depth. When flows depth increases to 3 or more times the protrusion height, the roughness is not very sensitive to depth.

### 3.2.5 Roughness Prediction Recommendations

The roughness estimates should begin with the methods developed by Rice et al. (1998), Equation 3-5. Results will provide an estimate conservative for fish passage criteria. If the resulting hydraulics cannot meet irrigation demands the Darcy-Weisbach methods can be applied. Uncertainty in the interstitial flow quantities will likely outweigh additional precision in the roughness method.

High flow conditions may require different roughness estimates. The figures present example variation to demonstrate processes and should not be applied to specific design cases.

### 3.2.6 Additional Energy Loss

The addition of step-pools, boulder clusters, debris jams, deflectors, etc. will create additional energy losses not accounted for in the roughness value and must

be treated separately. Entrances and exits to the ramp will also create additional energy losses.

### 3.3 Interstitial Flow Velocity

If the ramp is not sealed and water flows through the riprap layer, the amount passing under the surface should be subtracted from the total flow available. The flow rate is computed by continuity using the cross-sectional area of the riprap layer. Stephenson (1979) presents Equation 3-6 for computing flow through a riprap layer of crushed rocks.

$$v_i = n_p \cdot \left( S_0 \cdot g \cdot \frac{D_{50}}{K'} \right)^{1/2} \quad \text{Equation 3-6}$$

Where,

$v_i$  = quantity of flow passing through the riprap layer ( $\text{m}^3/\text{s}$ );

$n_p$  = porosity of the riprap layer;

$S_0$  = slope of the rock ramp;

$g$  = acceleration due to gravity ( $9.81 \text{ m/s}^2$ );

$D_{50}$  = representative rock diameter (m); and

$K'$  = friction coefficient  $\approx 4$ .

For the ramp design, the representative rock diameter can be taken as the  $D_{50}$ .  $K'$  is a function of the Reynolds number and for the high values expected on rock ramps,  $K'$  approximately equals 4.

In some cases the entire flow may pass through the interstitial spaces as subsurface flow within the ramp rather than over the surface. Unless the low-flow discharge can be increased, the surface of the low flow channel should be sealed.

Abt et al. (1987) presents two methods for estimating interstitial flow through the riprap layer. When the character of the riprap is known, Equation 3-7 estimates the interstitial flow.

$$v_i = 19.29 \cdot \left( c_u^{-0.074} \cdot S_0^{0.46} \cdot n_p^{4.14} \right)^{1.064} \cdot \sqrt{g \cdot D_{50}} \quad \text{Equation 3-7}$$

Where,

$v_i$  = interstitial velocity;

$c_u$  = coefficient of uniformity;

$S_0$  = slope of the embankment;

$n_p$  = porosity of the riprap layer;

$g$  = acceleration due to gravity ( $32.2 \text{ ft/s}^2$ ); and

$D_{50}$  = median diameter of riprap (in.).



When the character of the riprap is not fully known, Abt et al. found the  $D_{10}$  best predicts interstitial flow. Equation 3-8 presents the  $D_{10}$  method.

$$v_i = 0.232 \cdot \sqrt{g \cdot D_{10} \cdot S_0} \quad \text{Equation 3-8}$$

Where,

$v_i$  = interstitial velocity;

$g$  = acceleration due to gravity (ft/s<sup>2</sup>); and

$D_{10}$  = diameter of riprap (in.) with 10% by mass is finer; and

$S_0$  = slope of the embankment.

Abt et al. (1987) test used slopes from 1% to 20% for  $D_{50}$  diameters of 1 in. to 6 in. Equation 3-6, Equation 3-7, and Equation 3-8 represent empirical measurements applied to typical riprap gradations (see Chapter 4.5). Application to gradations outside the range of recommendations will reduce accuracy. Designs should use conservative values (high velocities).

### 3.4 Low Flow Normal Depth Hydraulics

Under low-flow conditions, downstream sections are unlikely to influence flow depths on the ramp. Therefore, hydraulics can be determined using normal depth calculations (the depth at which uniform flow would occur in an open channel). A backwater model such as HEC-RAS (Bruner 2002) or other methods can still be applied but may require more effort. Normal depth calculations provide a quick determination of the low-flow channel width and ramp length meeting low-flow fish passage depth and velocity conditions. A minimum flow rate, ramp geometry, and surface roughness estimate are needed for this calculation. This provides an initial determination of the ramp length, width, flow depth and velocity. If a trapezoidal channel does not provide enough depth for fish passage at low flows, a low flow notch would be necessary. In this case the initial determination of ramp length and flow depth and velocity would be based upon the low flow notch hydraulics. Normal depth would be determined in the center of the ramp length while the entrance and exit hydraulics will be affected by the upstream and downstream channel conditions. Entrance and exit hydraulics can also be estimated using a step-backwater model such as HEC-RAS. Normal depth is computed using continuity, Equation 3-9, and Manning's relationship, Equation 3-10.

$$Q = v \cdot A \quad \text{Equation 3-9}$$

Where,

$Q$  = discharge;

$v$  = average velocity over a cross section; and

$A$  = wetted cross sectional area.

$$v = \frac{\phi}{n} \cdot R^{2/3} \cdot S_f^{1/2} \quad \text{Equation 3-10}$$

Where,

$v$  = average velocity over a cross section;

$\phi$  = unit conversion factor, 1 for meters, 1.48 for feet;

$n$  = roughness coefficient;

$R$  = hydraulic radius =  $\frac{A}{P}$ ;

$A$  = wetted cross sectional area;

$P$  = wetted perimeter; and

$S_f$  = friction slope.

Under normal depth conditions the friction slope,  $S_f$ , equals the bed slope,  $S_0$ , which is a function of the ramp length and the drop height, Equation 3-11.

$$S_0 = \frac{h_d}{L_r} \quad \text{Equation 3-11}$$

Where,

$S_0$  = slope of the bed;

$h_d$  = height of the drop; and

$L_r$  = horizontal profile length of the ramp.

The designer selects the width and length of a ramp that meets depth and velocity criteria for fish passage. Low-flow channels can take on a number of shapes. Figure 3-8 shows two basic shapes for the low-flow channel only. The low-flow channel would appear as a notch within the high-flow channel.

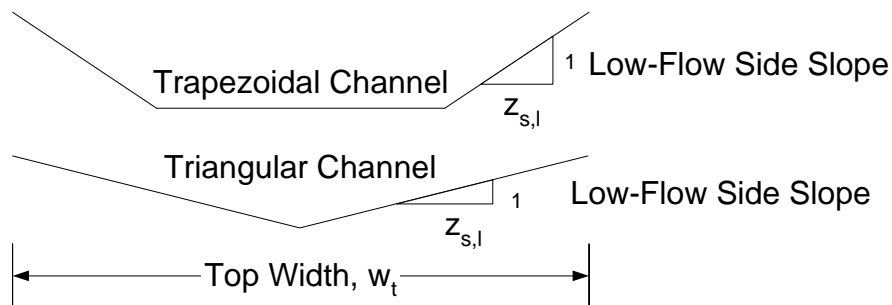

**Figure 3-8 Low Flow Channel Geometries**

The flat bottom of a trapezoid channel evenly distributes the flow depths across the channel while the point on a triangular channel creates a smaller region of flow at greater depths. A pointed trapezoid, not shown, compromises between the two options by placing a triangular bed within a larger trapezoid. Geometric relationships for the area and perimeter as a function of depth allow for computation of the normal depth and the normal-depth velocity.

Equation 3-12 shows the relationship for the area of a triangular channel as a function of depth and Equation 3-13 shows the equation for the wetted perimeter for the low flow notch only.

$$A = z_s \cdot y^2 \quad \text{Equation 3-12}$$

$$P = 2 \cdot y \cdot \sqrt{1 + z_s^2} \quad \text{Equation 3-13}$$

Where,

$A$  = wetted cross sectional area;

$z_s$  = side slope of the low flow channel;

$y$  = depth of flow; and

$P$  = wetted perimeter.

Equation 3-14 and Equation 3-15 show the area and perimeter relationships for a trapezoidal channel.

$$A = (B + z_s \cdot y) \cdot y \quad \text{Equation 3-14}$$

$$P = B + 2 \cdot y \cdot \sqrt{1 + z_s^2} \quad \text{Equation 3-15}$$

Where,

$P$  = wetted perimeter;

$B$  = bottom width;

$y$  = depth of flow; and

$z_s$  = side slope of the low flow channel.

A pointed trapezoid uses a mix of the triangular and trapezoidal functions depending on depth. While a triangular shape can be directly solved for normal depth, the trapezoidal and pointed trapezoidal shapes have no algebraic solution and must be solved iteratively.

Normal depth provides an idealized case for design purposes. In a constant slope and width reach, the flow will approach normal depth conditions. However, in the upstream and downstream transition the flow will deviate from normal depth calculations. Estimating the deviation requires performing additional hydraulic computations using a backwater or multi-dimensional model.

Solving the equations over a range of geometric configurations creates a series of depths and velocities. The designer must select an appropriate depth and velocity combination to meet fish passage criteria. Trapezoidal and triangular sections have two independent variables, width and slope. For pointed trapezoids, side slope of the low flow channel also acts independently. Triangles and trapezoids depth or velocity can be plotted as contours on a 3D graph as shown in the design example, Chapter 10. Pointed trapezoids require making a constant low flow side slope assumption. Different bottom geometries can be compared by establishing a common parameter, such as width and varying side slope. For

equivalent discharges and the same top width, triangular sections create greater depths over the thalweg of any geometry.

### 3.5 High Flow Conveyance Geometry

High-flow geometry is constrained by the existing channel geometry and the low flow channel. The only hydraulic design variables remaining are the bottom width and side slope in a trapezoidal channel. For a ramp with a low flow notch (Figure 3-1b), the two transverse bed slopes (within the notch and across the bed), side slopes (within the notch and across the bed), and channel width are the design variables. Flatter side slopes allow smaller riprap diameters, but the bottom width must be wide enough to avoid choking the flow and increasing the upstream stage during floods. A specific energy diagram provides a means of evaluating the minimum width. Equation 3-16 shows the formula for balancing the specific energy (Bernoulli).

$$E = h_1 + \frac{v_1^2}{2 \cdot g} = h_2 + \frac{v_2^2}{2 \cdot g} + \Delta z \quad \text{Equation 3-16}$$

Where,

$E$  = specific energy of the flow;

$h_{1,2}$  = depth of flow upstream and on the crest;

$v_{1,2}$  = average cross section velocity upstream and on the crest;

$g$  = acceleration due to gravity; and

$\Delta z$  = change in elevation from between section 1 and 2.

The flow becomes choked when the specific energy of the ramp crest falls below the available energy from upstream. The threshold for this occurs at critical flow where the Froude number equals 1, Equation 3-17.

$$Fr = 1 = \frac{v_2}{\sqrt{g \cdot h}} \quad \text{Equation 3-17}$$

Where,

$Fr$  = Froude number;

$v_2$  = average velocity in the downstream section;

$g$  = acceleration due to gravity; and

$h$  = hydraulic depth of the crest section.

Equation 3-16 and Equation 3-17 can be simultaneously solved to determine the downstream velocity when the upstream critical depth equals the upstream normal depth. Continuity, Equation 3-9, and geometry equations relating depth and area result in the minimum width and maximum side slopes to avoid choking the flow.

The cross section area is a function of the ramp geometry. Chapter 10 contains example calculations for determining minimum ramp parameters. Designers may select a wider channel to increase conveyance capacity.

HEC-RAS accounts for changes in geometry though incorporating additional losses into the gradually varied flow equations. Loss is proportional to the difference in the squared velocities from upstream to downstream. Contractions, which reflect an increase in velocity, use a different coefficient than expansions, reflected by a decrease in velocity. Coefficients are empirical and analysis requires an iterative procedure. Literature review could not identify energy loss coefficients applicable to rock ramps.

### **3.6 High Flow Backwater Modeling (Riprap Design)**

A range of flows should be calculated to develop flow characteristics for various discharges. Normal depth calculations can provide a first approximation for the purpose of determining the best low flow channel conditions to meet fish passage criteria. A backwater model should be used for final design for low and high-flow conditions. The site specific conditions should be evaluated to determine if two-dimensional, 2D, or three-dimensional, 3D, effects may play a significant role. 2D effects can be significant if there is a rapid or abrupt change in width. 3D effects should be accounted for if there is a sharp planform bend in the ramp or vertical flow such as a hydraulic drop or step.

The HEC-RAS (Brunner 2002) software package provides a means of computing hydraulics for gradually varied flow. Refer to the manual and associated example and reference documentation. Specific guidelines applicable to rock ramps include:

- Change in Conveyance Between Sections;
- Expansion and Contraction;
- Additional Roughness Elements: bends, debris, and vegetation; and
- Critical Flow Transitions.

Geometry of the ramp can be modified to reduce the shear stress on the ramp during high flow conditions and decrease the riprap size and downstream transition and scour protection. Changes may impact the low flow hydraulics are requires checking to make sure all constraints are met.

### **3.7 Rock Ramp Geometry Design Procedure**

The following steps utilize ramp geometry and hydraulics to size riprap that meet site conditions, has suitable conditions for fish passage at low flow, and passes high flows:

1. Guess an initial riprap diameter and longitudinal slope to estimate a roughness value.
2. Estimate ramp geometric parameters and generate low-flow hydraulics to meet fish passage requirements and project constraints.
3. Iterate the slope and roughness until constraints are satisfied.
4. Determine the high-flow design discharge.
5. Iterate high flow geometry to provide adequate flood flow passage.
6. Determine the high-flow riprap design discharge.
7. Compute riprap diameters.
8. Compute riprap gradation and thickness.
9. Update the roughness estimate and iterate until all conditions are satisfied.
10. Design entrance and exit transitions.
11. Biologic review to validate fish passage characteristics.
12. Add special features such as boulder clusters or step pools.
13. Review the impact from special features on the basic design.

The design procedure fixes the geometry of the ramp and establishes flow conditions acceptable for fish passage. Critical fish passage conditions occur during low flow time periods. Critical conditions for survival of the structure depend on high flow conditions.

### **3.8 Summary**

This chapter provides an overview of methods to evaluate the hydraulics of rock ramp structures. A review of roughness methods identified Rice et al (1998), Section 3.2.3, as a reasonable approach. Three methods for estimating interstitial velocity that can be used to calculate subsurface flow were provided and the most conservative should be to determining surface flow. The geometry designed for the ramp and the low flow hydraulics can use normal depth to identify a range of values meeting fish passage criteria. Evaluating the impact on upstream stage during high flows can be accomplished through specific energy analysis. The hydraulic analysis feeds the riprap design. After selecting a riprap diameter, roughness should be updated and hydraulics checked to ensure all criteria are met. The results from these design steps provide the designer a range of variables that can be further refined if necessary in later stages of the design process.

### **3.9 References**

Abt, S.R., Khattak, M.S., Nelson, J.D., Ruff, J.F., Shaikh, R.J., Wittler, R.J., Lee, D.W., and Hinkle, N.E. (1987) May. "Development of Riprap Design Criteria by Riprap Testing in Flumes: Phase I", NUREG/CR-4651, ORNL/TM-10100/V1, prepared for the US Nuclear Regulatory Commission, Washington D.C.

- Abt, S.R., Wittler, R.J., Ruff, J.F., LaGrone, D.L., Khattak, M.S., Nelson, J.D., Hinkle, N.E., and Lee, D.W. (1988) Sept. "Development of Riprap Design Criteria by Riprap Testing in Flumes: Phase II; Followup Investigation," Vol 2, NUREG/CR-4651, ORNL/TM-10100/V2, prepared for the US Nuclear Regulatory Commission, Washington D.C.
- Brunner 2002. *HEC-RAS River Analysis System User Manual Version 3.1*, US Army Corps of Engineers, Hydrologic Engineering Center, Davis, CA. November.
- Julien, P.Y. 2002. *River Mechanics*. Cambridge University Press, Cambridge, United Kingdom.
- Richardson, E.V., Simons, D.B., and Lagasse, P.F., 2001. *Hydraulic Design Series No. 6, River Engineering for Highway Encroachments, Highways in the River Environment*, U.S. Department of Transportation Federal Highway Administration, Publication No. FHWA NHI 01-004. p. 6.1-74.
- Rice, C.E., Kadavy, K.C., and Robinson, K.M., (1998). Roughness of Loose Rock Riprap on Steep Slopes. *Journal of Hydraulic Engineering*, 124:2 (179-185). February.
- Simons, D.B., Sentürk, F. 1992. *Sediment Transport Technology Water and Sediment Dynamics*. Water Resources Publication, Littleton, Colorado.
- Stevenson, D., (1979). *Rockfill in Hydraulic Engineering*. Amsterdam, the Netherlands: Elsevier.





## 4.0 Riprap Sizing

### 4.1 Overview

Riprap consists of immobile material designed to resist movement during flow up to a level known as the design discharge. The methods for determining the geometry of a rock ramp use both low and high-flow hydraulic conditions. The critical condition for stability and persistence of a structure occurs during high flows. The high flows determine the size of the riprap material.

Riprap sizing equations, even those with a theoretical basis, use empirically derived coefficients applicable to a specific range of conditions and types of processes. The equations should only be used in the specified range of conditions reported. Extending the equations outside the tested range may result in erroneous values. The methods used to develop a sizing relationship impact the factor of safety. In using empirically derived relationships between riprap size and hydraulic variables, there is some deviation or scatter from the central tendency of the data. Best fit relationships are used to most accurately predict the incipient motion of a rock with some data points scattered higher and some lower. An envelope curve captures the majority of points either above or below a certain threshold.

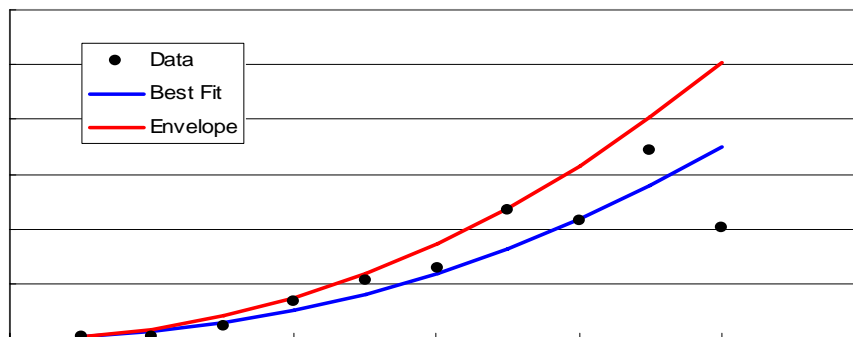

**Figure 4-1 Hypothetical Envelope Curve Example**

An envelope curve includes a degree of safety while a best-fit curve does not. The factor of safety for an envelope curve could be quantified using confidence limits but existing riprap equations do not report a statistical analysis and cannot quantify the likely amount of additional protection.

Riprap relationships report results in terms of a characteristic grain diameter. The diameter selected reflects many elements including whether the relationship was developed as a general incipient motion predictor or specifically a riprap design method. Incipient motion is defined as the hydraulic condition at which

the forces on a riprap stone are large enough that the stone begins to move along the bed.

Unless otherwise specified, general incipient motion predictors in the following text will be treated as a  $D_{30}$  for riprap design purposes. For the material placed into the ramp, 70% of the mass will be immobile at the design discharge. This guideline follows the USACE (1991) methods on riprap gradation.

In general, the sides of a ramp will slope at a steeper angle than the bed of the ramp. As the side slope angle increases, the size of the riprap increases as a result of the influence of gravity upon the riprap size. Overtopping embankment equations predict diameters for flow parallel to the bed slope while side slope equations are designed for flow perpendicular to the side slope. Some equations overlap. All methods apply to loose rock structures. Grout, articulated concrete blocks, mats, etc. are not included in the design but might still be considered as an alternative.

The quality of materials and method of construction can greatly improve the chances for success. Uniform gradations withstand higher discharges before initiation of motion (Abt et al. 1988) but risk piping of material through the layer in the absence of a filter. Incorporation of fine material into a gradation may seal against piping but can be less stable than the same gradation without fine material. This is owing to the fact that fines tend to be removed in the same general surface area of the ramp, causing greater local concentration of flow (Abt, personnel communication, 2006). Stable riprap gradations will be described in section 4.5. Rivers are dynamic systems and the bed-material gradation reflects processes of mobility and deposition. Rock ramps are intended to be static. Environmentally and ecologically beneficial designs allow upstream sediments to transport through the ramp while ramp stability is maintained.

## 4.2 Hydraulics

Riprap is designed to be stable up to certain high flow conditions. Chapter 3 developed the conditions for the low flow passage. Riprap design concerns the high flows and the entire structure. Rock ramps can be designed in two ways.

The first, case A, consists of a compound channel spanning ramp where the low-flow channel creates a notch within a larger high flow channel of equivalent length as shown in Figure 4-2.

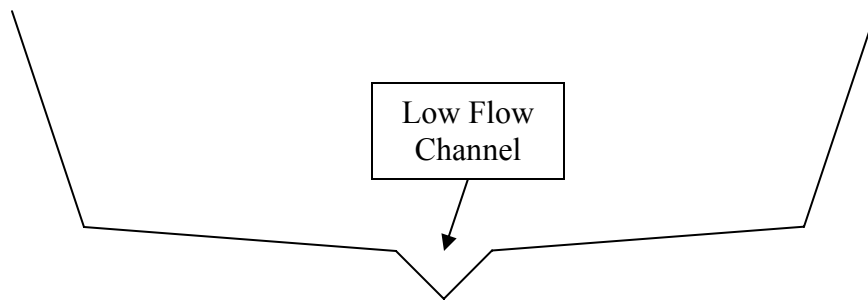

**Figure 4-2 Rock Ramp with Low Flow Channel (Case A)**

Case A contains three different sections that may be able to use different sized riprap material. Acquiring three different types of material may be less economical than applying the largest diameter to all areas. The second option, case B consists of a side channel. Higher flows pass over the sill of the structure and any excess flow in the rock ramp spills over. Figure 4-3 shows an example of case B.



**Figure 4-3 Rock Ramp and High Flow Sill (Case B)**

For case B, the bed and the side slopes may require different diameters to resist motion.

### **4.3 Embankment Overtopping (Bed) Riprap Sizing Relationships**

There are few relationships designed specifically for ramps. The processes for a ramp are similar to those for overtopping dam or levee embankments. Embankment relationships, as opposed to side slope relationships, compute stable rock diameters for material placed on the bed of a stream where the primary gradient is downstream. Watson, Biedenharn, and Thorne (2005) discuss a variety of stream rehabilitation methods and report several different sizing methods for sizing riprap including Abt and Johnson (1991), Whittaker and Jäggi (1986), Robinson et al. (1998), and Rosgen (2002). Along with several additional methods, the following relationships list different methods for estimating the required diameter of material for stability.

The selection of a riprap sizing relationship depends upon the conditions at the site and the methods used to develop the relationship. Equations are most

accurate when the range of conditions during development spans the range of conditions for the application. Unfortunately, overlap rarely occurs. Extrapolating carries risks and uncertainty. The equations most grounded in physical processes will extrapolate better than pure regression relationships.

USACE (1991) and Abt and Johnson (1991) provide well tested methods. Computing sizing by all methods and eliminating less reliable methods will provide a degree of confidence. There is no single answer or method for determining riprap size. The riprap diameters should be compared to the bed-material. If diameters are smaller than the bed-material, the riprap is likely mobile given the steeper slopes on a ramp.

#### 4.3.1 Abt and Johnson (1991)

Abt and Johnson (1991) performed near prototype flume studies for riprap on embankment slopes between 1 and 20 percent with stone sizes between 1 and 6 inches. Coefficients of uniformity,  $C_u = D_{60}/D_{10}$ , ranged from 1.62 to 2.15 and geometric standard deviations,  $\sigma_g = \sqrt{D_{84}/D_{16}}$ , from 1.86 to 5.70. Relationships were developed to determine the discharge at incipient motion as well as general failure. Incipient motion occurred at a discharge equal to 75% of the failure discharge. Abt and Johnson recommend increasing the unit design discharge by 35% as shown in Equation 4-1.

$$q_{\text{sizing}} = 1.35 \cdot q_{\text{design}} \quad \text{Equation 4-1}$$

Where,

$q_{\text{sizing}}$  = unit discharge to use when sizing material; and

$q_{\text{design}}$  = design unit discharge to protect against failure.

The sizing relationship reports an empirical fit to the testing results with additional coefficients to account for the distribution of error about the fit and observed failure mechanisms. Equation 4-2 shows the basic sizing relationship with factors included to account for design and failure mechanism uncertainties.

$$D_{50} = \phi_e \cdot \phi_c \cdot a \cdot 5.23 \cdot S_0^{0.43} \cdot q_{\text{design}}^{0.56} \quad \text{Equation 4-2}$$

Where,

$\phi_e$  = coefficient for the empirical envelope on the regression relationship = 1.2;

$\phi_c$  = coefficient for flow concentration due to channelization within the revetment;

$a$  = shape factor for rounded versus angular material;

$D_{50}$  = median diameter of the riprap layer, in;

$S_0$  = profile slope of the rock ramp; and

$q_{\text{design}}$  = design unit discharge, ft<sup>3</sup>/s/ft

Abt and Johnson recommended an envelope coefficient,  $\phi_e$ , equal to 1.2 to encompass the maximum deviation of all testing data. Channelization formed by preferential flow paths could increase the unit discharge up to a factor of 3. The flow concentration factor,  $\phi_c$ , accounts for the difference between water flowing at uniform depth across the entire channel versus concentrated over local areas. The coefficient of flow concentration can be computed from Equation 4-3.

$$\phi_c = r_q^{0.56} \quad \text{Equation 4-3}$$

Where,

$\phi_c$  = coefficient for flow concentration due to channelization within the revetment; and

$r_q$  = ratio of unit discharge in a channel versus unit discharge for a uniform depth.

The value for the flow concentration factor,  $\phi_c$ , from a 3 fold increase in unit discharge,  $r_q$ , is scaled by 1.85. The value  $r_q$  can also be computed as the ratio of the unit discharge in the low flow notch to the cross sectional average unit discharge at the peak design flow.

Rounded material was found to fail at a unit discharge 35% to 45% less than the unit discharge at failure for angular material. Equation 4-4 shows the relationship for computing the shape factor,  $a$ , to account for rounded material.

$$a = \left( \frac{1}{1 - r_s} \right)^{0.56} \quad \text{Equation 4-4}$$

Where,

$a$  = shape factor for non-angular material; and

$r_s$  = fractional reduction in unit discharge.

When using rounded stone and assuming a 45% reduction in the unit discharge ( $r_s=0.45$ ) at failure,  $a = 1.40$ .

#### 4.3.2 Ullmann (2000)

Ullmann (2000) expanded on the work of Abt and Johnson (1991) to include rounded riprap in design methods. Ullmann provides the only relationship to explicitly account for rounded material. Stone diameters ranged from 1 to 4 in., slopes included 20, 25, and 30% grades, percent rounded rock ranged from 55 to 92%, the coefficient of uniformity ranged from 1.21 to 2.4. Ullmann measured the coefficient of uniformity,  $D_{60}/D_{10}$ , to account for different gradations and percent roundedness, visually classified, to account for angularity.

Equation 4-5 shows a riprap sizing relationship for rounded material.

$$D_{50} = 6.84 \cdot S_0^{0.43} \cdot q_f^{0.56} \cdot C_u^{0.25} \cdot (1.12 \cdot R + 0.39) \quad \text{Equation 4-5}$$

Where,

$D_{50}$  = median diameter of stable riprap;

$S_0$  = slope of the embankment;

$q_f$  = discharge at failure (see Abt and Johnson above);

$C_u$  = coefficient of uniformity,  $D_{60}/D_{10}$ ; and

$R$  = percent roundedness in decimal form.

Ullmann found rounded rock shapes required a 46% increase in median stone size. As with angular material more uniform gradations withstand higher discharges. The coefficient in Ullmann's relationship includes an envelope factor as well as a discharge modification factor to prevent initiation of motion before failure.

### 4.3.3 Ferro (1999)

Ferro (1999) used dimensional analysis to develop a sizing relationship based on data from Abt and Johnson (1991) and Robinson et al. (1998). The best fit relationship is shown in Equation 4-6.

$$\frac{D_{50}}{B} = \phi_e \frac{0.95}{(\sigma_g^2)^{0.562}} \cdot \left( \frac{Q \cdot S_0}{B^{5/2} \cdot g^{1/2}} \cdot \frac{\gamma_s - \gamma}{\gamma} \right)^{1/2} \quad \text{Equation 4-6}$$

Where,

$D_{50}$  = median grain diameter;

$B$  = channel width (rectangular cross section);

$\phi_e$  = coefficient to include all of the empirical data in the regression relationship = 1.4;

$\sigma_g^2$  = geometric variance of the gradation =  $D_{84}/D_{16}$ ;

$Q$  = total discharge;

$S_0$  = longitudinal slope of the ramp;

$g$  = acceleration due to gravity;

$\gamma_s$  = specific weight of stone; and

$\gamma$  = specific weight of water.

Ferro recommends that  $\phi_e$  of 1.4 be used to cover all of the empirical data. Slopes are reported between 2% and 40%, specific gravity of stone between 2.5 and 2.82, riprap thicknesses of twice the  $D_{50}$ , and angular material.

### 4.3.4 Robinson et al. (1998)

Robinson et al. (1998) performed testing of riprap stability specifically for rock ramps. Slope ranged from 2 to 40%, diameters ranged from 15 to 287mm, coefficients of uniformity ranged from 1.25 to 1.73, and the geometric standard deviation ranged from 1.15 to 1.47. Failure was defined as exposure of the substrate. Equation 4-7 shows the relationship.

Error! Objects cannot be created from editing field codes. **for  $S_0 < 0.10$**

$$D_{50} = \left( \frac{q_{design}}{8.07 \cdot 10^{-6} \cdot S_0^{-0.58}} \right)^{0.529} \quad \text{for } 0.10 < S_0 < 0.4 \quad \text{Equation 4-7}$$

Where,

$D_{50}$  = median grain size, mm.

$q_{design}$  = unit discharge, m<sup>3</sup>/s/m;

$S_0$  = ramp slope; and

The functions were developed using median diameters,  $D_{50}$ , ranging from 15 to 278 mm, coefficient of uniformity,  $C_u$ , ranging from 1.25 to 1.73, geometric standard deviation,  $\sigma_g$ , between 1.15 to 1.47, and specific gravities from 2.54 to 2.82.

#### 4.3.5 USACE (1991) Bed

For a riprap on beds with slopes ranging between 2 and 20%, the U.S. Army Corps of Engineers (EM1601, 1994) presents the following dimensionless relationship, Equation 4-8.

$$D_{30} = \frac{1.95 \cdot S^{0.555} \cdot q^{2/3}}{g^{1/3}} \quad \text{Equation 4-8}$$

Where,

$D_{30}$  = rock diameter for which 30% is smaller by mass;

$S$  = slope of the rock ramp;

$q$  = design unit discharge, USACE (EM1601, 1994) recommends increasing the input  $q$  by a 1.25 flow concentration factor; and

$g$  = acceleration due to gravity.

The range of applicability requires a thickness equal to 1.5 \* $D_{100}$ , angular rock with a unit weight of 167 lbs/ft<sup>3</sup>,  $D_{85}/D_{15}$  from 1.7 to 2.7, and side slopes flatter than 2.5:1 (H:V). The  $D_{50}$  is related to the  $D_{30}$  according to Equation 4-9.

$$D_{50} = D_{30} \cdot \left( \frac{D_{85}}{D_{15}} \right)^{1/3} \quad \text{Equation 4-9}$$

The Corps recommends using a filter fabric below the structure and suggests considering grouted rock instead of loose stone.

#### 4.3.6 Whittaker and Jäggi (1986)

Whittaker and Jäggi (1996) studied the movement of riprap and found the relationship shown in Equation 4-10.

$$\frac{q}{\sqrt{g \cdot D_{65}^3 (G-1)}} \leq \frac{0.257}{S_0^{7/6}} \quad \text{Equation 4-10}$$

Where,

$q$  = Specific discharge,  $m^3/s/m$ ;

$D_{65}$  = diameter of material which 65% is finer;

$G$  = specific gravity of the rock;

$S_0$  = ramp gradient; and

$g$  = acceleration due to gravity  $m/s^2$ .

Whittaker and Jäggi suggest increasing the input discharge by 10 to 20%. Information on the ranges of material tested was not included in the translation.

#### 4.3.7 Equations Investigated but Not Recommended

##### **Rosgen (2002)**

Rosgen (2002) is not recommended due to a lack of physical background for developing the relationship using bed the shear stress as an input parameter. The stress on the ramp material depends upon the characteristics of the structure, not the channel.

Rosgen (2002) reported the empirically derived a semi-log regression relationship for the minimum rock size when constructing cross-vanes, w-weirs, and j-hook vanes shown in Equation 4-11.

$$D_{\min} = 0.1724 \cdot \ln(\tau_{bf}) + 0.6349 \quad \text{Equation 4-11}$$

Where,

$D_{\min}$  = minimum rock diameter, m;

$\tau_{bf}$  = bankfull shear stress,  $N/m^2 = \gamma R S_f$ ;

$\gamma$  = unit weight of water,  $N/m^3$ ;

$R$  = hydraulic radius, m; and

$S_f$  = friction slope of the water surface down the rock ramp, m/m.

Shear stress ranges from 0 to 25  $N/m^2$  and a note cautions users to limit application to streams with bankfull discharges between 0.5 and 114  $m^3/s$  and mean depths between 0.3 and 1.5 m. The design implementation will treat the mean depth as the hydraulic depth at bankfull. No confidence intervals or goodness of fit statistics were available, but visual examination shows an upper envelope around 20% of the computed minimum rock diameter. The units of the bankfull shear stress were reported in  $kg/m^2$ , but were assumed to be  $N/m^2$ .

Rosgen's relationship applies to structures composed of individual large blocks where the loss of a single rock creates a hole in the structure. Rock ramps use a blanket of material where the loss of any single rock does not impact the performance of the structure as a whole. The equation is not highly applicable for comparison, but could be used to form a crest.



### **Modified Shields Parameter**

Mishura and Ruff (1989) is not recommended due to high range of scatter on the empirical fits and an unpredictable safety factor on the final result.

Mishura and Ruff (1989) developed a riprap sizing relationship based on the Shields parameter and compared results against testing on steep slopes. For a slope of 0.02 the relationship agreed well with testing data. For steeper slopes, the relationship became more and more conservative by predicting larger rock requirements than laboratory testing. At a slope of 0.10 the equation over predicted median diameters by an average of 0.02 meters. At a slope of 0.20, the equation over predicted rock diameters by 0.1 to 0.3 meters. Testing continued up to slopes of 0.50 with deviations ranging from 0.5 to 1.0 meters. Mishura and Ruff developed a correction coefficient that more closely aligns the relationship with observed data but results in a non-conservative estimate. The relationship appears somewhat applicable at slopes less than 0.20 without using the correction coefficient. Equation 4-12 shows the relationship rearranged to solve for  $D_{50}$ .

$$D_{50} = \frac{\tau_{cr}}{\tau_*} \cdot \gamma \cdot (G \cdot \cos(\alpha) - 1) \cdot (\cos(\alpha) \cdot \tan(\psi) - \sin(\alpha)) \quad \text{Equation 4-12}$$

Where,

$D_{50}$  = median grain diameter;

$\tau_{cr}$  = shear stress at the design condition;

$\tau_*$  = non-dimensional shields parameter (requires a lookup table);

$\gamma$  = unit weight of water;

$G$  = specific gravity of the rock material;

$\alpha$  = slope of the embankment represented as an angle; and

$\varphi$  = angle of repose of the riprap material.

Mishura and Ruff compute the critical shear stress,  $\tau_c$ , according to a force balance assuming hydrostatic vertical pressure distribution, Equation 4-13.

$$\tau = \gamma \cdot R \cdot S_0 \quad \text{Equation 4-13}$$

The non-dimensional shields parameter can be referenced from a sediment transport text book and changes with rock diameter. The hydraulic radius,  $R$ , was solved for using Manning's equation with roughness computed according to Strickler (1923), yielding the relationship in Equation 4-14.

$$D_{50} = 3.56 \cdot q^{0.667} \cdot S_0^{-0.33} \cdot \left( \frac{\sin(\alpha)}{(G \cdot \cos(\alpha) - 1) \cdot (\cos(\alpha) \tan(\varphi) - \sin(\alpha))} \right)^{1.11} \quad \text{Equation 4-14}$$

Where,

$D_{50}$  = median grain diameter;

$q$  = design unit discharge;

$S_0$  = slope of the rock ramp;

$\alpha$  = angle of the ramp equal to the  $\tan^{-1}(S_0)$ ; and

$G$  = specific gravity of the riprap.

Mishura and Ruff's results provide a conservative estimate which grows even more conservative as the slope increases. It is not recommended to use the version without the deviation correction on slopes over 0.20 as the rocks will be sized too large.

## 4.4 Side Slope Riprap Sizing Relationships

Side slope riprap sizing incorporates the slope of the bank and weaker influences of gravity as a stabilizing force. The USACE (1991) method provides a good estimate for side slope riprap diameters.

### 4.4.1 Individual Stone Stability

Many authors report stone stability relationships based on the theoretical force balance acting on a particle. Stevens (1976) and Simons and Sentürk (1992) report the following methodology using Equation 4-15 through 4-18.

$$SF = \frac{\cos(\theta) \cdot \tan(\phi)}{\eta' \cdot \tan(\phi) + \sin(\theta) \cdot \cos(\beta)} \quad \text{Equation 4-15}$$

$$\eta' = \eta \cdot \frac{1 + \sin(\lambda + \beta)}{2} \quad \text{Equation 4-16}$$

$$\eta = \frac{1}{\tau_*} \frac{\tau_0}{(G - 1) \cdot \gamma \cdot D_s} \quad \text{Equation 4-17}$$

$$\beta = \tan^{-1} \left( \frac{\cos(\lambda)}{\frac{2 \cdot \sin(\theta)}{\eta \cdot \tan(\phi)} + \sin(\lambda)} \right) \quad \text{Equation 4-18}$$

Where,

SF = safety factor for motion;

$\theta$  = side slope angle;

$\phi$  = angle of repose of the material;

$\lambda$  = angle of the vertical velocity component with respect to the horizontal;

$\tau_*$  = critical dimensionless shields parameter;

$\tau_0$  = shear stress (tractive force);

$G$  = specific gravity of the rock;

$\gamma$  = unit weight of water; and

$D_s$  = rock diameter.

$\eta$ ,  $\eta'$ , and  $\beta$  can be treated as placeholders. The development of an individual stone stability relationship includes many assumptions to simplify the equations into a solvable relationship. Simons and Sentürk (1992) work through the development process including the required assumptions. Exceptions applicable to rock ramps include:

- Lift and Drag: High velocities violate the assumed ratio between lift and drag.
- Rock Geometry: Deviation from the assumed shapes will result in different forces.

The impact of these unknowns and assumptions can be mitigated through the use of angular rock. Colorado State University is working to improve the understanding of the stone stability force balance.

#### 4.4.2 USACE (1991) Side Slope

The Army Corps method outlined in Engineering Manual EM1601 describes a procedure for designing riprap revetments on banks using Equation 4-19.

$$D_{30} = SF \cdot C_s \cdot C_v \cdot C_t \cdot y \cdot \left[ \left( \frac{\gamma}{\gamma_s - \gamma} \right)^{1/2} \cdot \left( \frac{v_L}{\sqrt{k_1 \cdot g \cdot y}} \right) \right]^{2.5} \quad \text{Equation 4-19}$$

Where,

$D_{30}$  = riprap diameter;

$SF$  = safety factor, typically 2 to 3;

$C_s$  = stability coefficient for incipient failure (adjusts for rock shape);

$C_v$  = vertical velocity coefficient (accounts for plan form bends);

$C_t$  = blanket thickness (smaller diameter for thicker revetment);

$y$  = local depth of flow;

$\gamma$  = unit weight of water;

$\gamma_s$  = unit weight of rock;

$v_L$  = local depth averaged velocity;

$k_1$  = side slope correction factor; and

$g$  = acceleration due to gravity

For a full discussion of the Army Corps EM1601 method, refer to the Engineering Manual.

## 4.5 Riprap Layer Thickness

The thickness of the riprap layer should fully contain the largest particles such that no rocks protrude into the flow. The U.S. Army Corps of Engineers (EM1601, 1994) recommends a thickness of the larger of 1.5 the  $D_{50}$  or the  $D_{100}$ .

$$T \geq \max(1.5 \cdot D_{50}, D_{100}) \quad \text{Equation 4-20}$$

Where,

$T$  = thickness of the riprap layer;

$D_{50}$  = median diameter of riprap gradation by mass; and

$D_{100}$  = maximum diameter of the riprap gradation.

Increasing the layer thickness increases the ability of a riprap layer to self heal as well as withstand weak spots due to discontinuities in the layer from construction or debris impact. There is little guidance on increasing the layer thickness. Larger riprap diameters are less susceptible to discontinuities.

## 4.6 Riprap Gradation

A riprap revetment does not contain material of uniform diameter, but rather a range of materials. The gradation of the riprap blanket has several goals:

- Maintain a layer of immobile interlocking stone: Zones of preferential flow creating local stresses in excess of design capabilities can form in riprap ramps and revetments.
- Prevent piping of substrate material: Undercutting of a revetment through small substrate particles entrained up through the layer can cause a revetment to fail.
- Release pore water pressure: Excessive pore water pressure creates uplift pressures on the stones within a revetment and may cause a revetment to fail.

A riprap layer of uniform diameter maximizes the interlocking forces between particles and reduces the likelihood of channels forming on the surface to concentrate flow and cause premature failure. A wider range of sizes reduces the ability of a stream to pull material through the riprap layer and undermine the structure through piping. The final gradation represents a compromise between resistance to hydraulic entrainment and resistance to piping. A gradation meeting interlocking and piping criteria will likely meet pore water pressure objectives.

Simons and Sentürk (1992) report ratios of characteristic diameters. The gradation should be smooth with the smallest sizes in the gravel range. Equation 4-21 shows the ratio of the  $D_{50}$  to the  $D_{100}$  and Equation 4-22 shows the ratio of the  $D_{50}$  to the  $D_{20}$ .

$$D_{100} = 2 \cdot D_{50} \quad \text{Equation 4-21}$$

$$D_{20} = D_{50} / 2$$

Equation 4-22

Where,

$D_{100}$  = maximum stone diameter;

$D_{50}$  = median grain diameter; and

$D_{20}$  = characteristic diameter of which 20 percent is smaller.

The Army Corps of Engineers in Engineering Manual (EM1601, 1994) reports a range of gradations depending on the computed  $D_{30}$ . Several other design guideline report on the coefficient of uniformity and geometric standard deviation. Gradations outside the reported range require an analysis of potential failure modes and may require countermeasures or design modifications.

The coefficient of uniformity measures the relative amount of fine material in a riprap gradation. Riprap design assumes smooth gradation curves. A wide spread of material can help resist piping of substrate from causing failure but may preferentially erode at flows less than the design discharge. Removal of fine material can create channels within the riprap protection with stresses higher than the design discharge and can cause the ramp to fail.

Literature, field testing, and physical model testing report the most stable uniformity coefficients ( $C_u = D_{60}/D_{10}$ ) range from 1.7 to 2.4. Table 4-1 summarizes the range of recommended gradations.

**Table 4-1 Design Coefficients of Uniformity**

Source	$C_u$
Abt and Johnson (1991)	1.62 to 2.15
Robinson et al. (1998)	1.25 to 1.73
U.S. Army Corps of Engineers (EM1601, 1994)	$D_{85}/D_{15} < 2$
Simons and Sentürk ()	$D_{50}/D_{20} = 2$
Lagasse et al. (1995)	$\sim 2.4$

Existing tests on riprap show lower coefficients of uniformity result in more resistant structures, but also more catastrophic failure once incipient motion is exceeded. Abt and Johnson and Robinson et al. specifically address overtopping embankments. The U.S. Army Corps of Engineers provides gradations for both bed and banks. For rock ramps, the coefficient of uniformity should be less than 2.0 unless site specific conditions warrant otherwise and the design accommodates higher values.

## 4.7 Riprap Filter Criteria

Filters may be required to prevent undercutting of the rock ramp through piping and may consist of gravel or manufactured materials. Filters allow engineers to satisfy stable gradation requirements while preventing piping of the underlying material (base).

Simons and Sentürk (1992) present the following relationship for the ratio between filter (or filter material) and the underlying base material. The riprap

may serve as the filter if the gradation meets the criteria shown in Equation 4-23, Equation 4-25, and Equation 4-24.

$$\frac{D_{50,Filter / Riprap}}{D_{50,Base}} < 40 \quad \text{Equation 4-23}$$

$$5 < \frac{D_{15,Filter / Riprap}}{D_{15,Base}} < 40 \quad \text{Equation 4-24}$$

$$\frac{D_{15,Filter / Riprap}}{D_{85,Base}} < 5 \quad \text{Equation 4-25}$$

If the riprap gradation does not meet the filter requirements, a filter layer should be considered. Adjusting the gradation of the riprap requires reevaluating the stable diameter and may warrant increasing the flow concentration factors in the design process. In extreme cases, multiple filter layers may be required to satisfy the ratios between surface and underlying material. A filter fabric may be used instead loose rock.

## 4.8 Upstream Cutoff Wall

An upstream cutoff wall is required for differences in water surface elevation greater than 5 feet from the upstream end to the downstream end of a structure. The lack of a cutoff wall may allow fine material to pipe through the structure and cause settling and failure of the structure. *Design of Small Canal Structures* (Aisenbrey et al., 1995) demonstrates Lanes' weighted creep method.

## 4.9 Downstream Transition

The downstream end of the rock ramp should have a flatter than the rest of the ramp, approximately 10H:1V or lower. The riprap blanket should be thickened or extended below the anticipated scour depth. Stilling basin design is described in *EM-25 Hydraulic Design of Stilling Basins and Energy Dissipaters* (Peterka, 1978).

## 4.10 Construction Concerns

The strongest ramp consists of a surface where the rocks are aligned and packed tight together. Land owners, biologists, and the site engineer may provide additional concerns for designers to address. Most sites will warrant special considerations.

## 4.11 Summary

Riprap design consists of identifying diameters large enough to resist movement and determining a gradation or filter layer to prevent piping of underlying material. The hydraulics of the highest flow the rock ramp will be required to withstand will determine the required diameters. The riprap equations produce a range of diameters. The Abt et al., Robinson et al., USACE, and Whittaker and Jäggi relationships provide well validated results with a sound basis. To check results, diameters should be larger than the material found in the system.

Recommended riprap gradations use empirical field results with limited laboratory testing. Gradations outside the range used to develop the relationships may weaken the riprap layer and cause failures at flows below the design events. The riprap may require a filter layer to prevent undermining through piping of the substrate through voids in the riprap material.

## 4.12 References

- Abt, S.R. and Johnson, T.L. (1991). "Riprap design for overtopping flow," *J. Hydraulic Engineering*, 117(8):959-972.
- Aisenbrey, A.J. Jr., Hayes, R.B., Warren, H.J., Winsett, D.L., and Young, R.B., (1995). *Design of Small Canal Structures*. U.S. Department of the Interior, Bureau of Reclamation. Water Resources Publications, LLC., Englewood, CO.
- Ferro, V. (1999). Design Relationships for Rock Chute Channels. *Transactions of the ASAE*. 43(3) pp. 585-590. Nov.
- Lagasse, P.F., Schall, J.D., Johnson, F., Richardson, E.V., and Chang, F. (1995). *Hydraulic Engineering Circular No. 20, Stream Stability at Highway Structures, Second Edition*. FHWA HI 96-032 HEC 20. U.S. Department of Transportation, Federal Highway Administration, National highway Institute. November.
- Mishura, S.K. and Ruff, J.F. (1989). *Riprap Design for Overtopping Embankments*. Prepared for U.S. Bureau of Reclamation, Denver by Colorado State University Engineering Research Center, Fort Collins, CO. October.
- Peterka, A.J., (1978). *EM-25 Hydraulic Design of Stilling Basins and Energy Dissipaters*. A Water Resources Technical Publication Engineering Monograph No. 25. United States Department of the Interior, Bureau of Reclamation, Denver, CO.
- Robinson, K.M., Kadavy, K.C., and Rice, C.E. (1998). Rock chutes on slopes between 2 and 40 percent. 1998 ASAE Annual International Meeting.
- Rosgen, D.L. (2002). *The cross-vane, W-weir and J-hook vane structures... Their description, design and application for stream stabilization and river restoration*.

- Simons, D.B., Sentürk, F. 1992. *Sediment Transport Technology Water and Sediment Dynamics*. Water Resources Publication, Littleton, Colorado.
- Stevens, M.A., Simons, D.B., Lewis, G.L. (1976). "Safety Factors for Riprap Protection," *American Society of Civil Engineers, Journal of the Hydraulics Division*, Vol. 102, HY5.
- Strickler, A. (1923). Beiträ zur Frage der Geschwindigkeitsformel und der Rauhligeitszahlen für Ströme, Kanäle und Geschlossene Leitungen. Vol 16 (Mitt. Des Eidgenössischen Amtes für Wasserwirtschaft, Bern, Switzerland. (Translation T-10, W.M. Keck, Laboratory of Hydraulics and Water Resources, California Institute of Techniloy, USA, 1981).
- Ullmann, C., (2000). *Rounded Riprap in Overtopping Flow*. Masters Thesis, Colorado State University, Fort Collins.
- EM1601 (1994). *Hydraulic Design of Flood Control Channels, EM-1110-2-1601*. U.S. Army Corps of Engineers. Washington, D.C.. June 30.
- Watson, C.C., Biedenharn, D.S., and Thorne, C.R., (2005). *Stream Rehabilitation, Version 1.0*. Cottonwood Research LLC., Fort Collins, CO.
- Wittaker, J. and Jäggi, M. (1986). *Blockschewelen*. Reports by the Research Institute for Water Engineering, Hydrology, and Glaciology. No. 91, Zurich. Translated by Hollingsworth, I.C., Bureau of Reclamation, Denver.



## **5.0 Fish Swimming Capabilities and Passage Criteria**

### **5.1 Introduction**

An extensive literature review was conducted to provide information on the following topics:

- Swimming speeds and leaping capabilities for threatened and endangered salmon and steelhead in Oregon and Washington
- Depth and velocity fish passage criteria for threatened and endangered salmon and steelhead.
- State and Federal fish passage criteria for the Pacific Northwest.
- Design criteria for rock passage structures, rock weirs, boulder clusters, nature like fishways, and natural rock and loose rock passage structures.

An extensive collection of literature was obtained and reviewed. A large number of scientific publications on salmon and steelhead swim speeds were summarized in an Excel spreadsheet and included as Appendix A. Depth and velocity passage criteria from state and federal fisheries agencies were also obtained in addition to a broad array of journal and technical articles on nature-like fishway designs. The most salient points are included in this literature review.

### **5.2 Swim Speeds for Anadromous Fish**

A large number of studies have been done to determine swimming speed capabilities for anadromous fish. These have been summarized in the Swim Table for Salmon and Steelhead in Appendix A. The literature on fish swimming abilities for chinook, coho, sockeye, chum, and steelhead generally agree on the swimming speeds and times to fatigue. Differences among the studies can mostly be attributed to differences in study design and testing apparatus (Kahler & Quinn 1998). No specific studies to determine swim speed capacities for federally listed threatened or endangered anadromous fish in Oregon and Washington have been conducted to date. However, adequate design criteria can be developed using the extensive literature available for non-special status anadromous species.

One of the most important concepts that should be considered is that multiple species and multiple life stages need to be accommodated when designing fish passage structures, particularly in an era when many resident species (non-migratory) are listed as threatened, endangered or species of concern. Additionally many resident species are of high value for sporting or commercial

purposes. Land management agencies are increasingly managing for biodiversity and are placing emphasis on protecting a wide range of aquatic species.

Fish passage for all life stages of anadromous fish as well as resident fish must be considered. In many situations, rearing juvenile salmonids migrate upstream, seeking nutrient-rich low velocity habitats, or habitats with more suitable flows or temperatures. The outmigrating juveniles of salmon and steelhead also need access to safe downstream passage, as do the upstream migrating spawning adults.

In order to understand the terms used in the Swim Table for Salmon and Steelhead, the following definitions are provided:

$U_{crit}$  is a measure of swimming performance and is the approximate speed at which fish fatigue in an incremental velocity test. Adults swim below and above  $U_{crit}$  during upstream migration using burst and coast strategies (Geist et al. 2003). The practical application of critical swimming speed data is to establish water velocity criteria for fishways. For example if  $U_{crit}$  (using 30-min time intervals) for a particular fish were found to be 50.0 cm/s, it would be expected that the fish could swim at 50.0cm/s for periods up to 1,800 s (30 min x 60 s/m). If velocity criteria for a 50-m long culvert were required, and if the fish were to swim for 30 min during the ascent, the speed of the individual relative to the culvert would be 2.8 cm/ s (5,000 cm/1,800 s). If the fish were to swim at 50.0 cm/s (i.e. critical swimming speed), water velocity in the culvert could not exceed 47.2 cm/s (50.0 cm/s - 2.8 cm/s) or the fish would fatigue prior to exiting the structure. Therefore, the maximum allowable water velocity for that culvert would be 47.2 cm/s (Peak 2004).

**Sustained speed** is defined by Beamish (1978) as a swim speed that can be maintained for more than 200 min.

Blaxter (1969) defined three fish swimming speeds: **burst, prolonged, and sustained**. **Burst** speeds may be 3 or 4 times as fast as prolonged speed, but fish can only maintain burst speeds for about 15 seconds. **Prolonged** speed can be maintained for up to 200 minutes. **Sustained** speed can be maintained for longer than 200 minutes.

The US Army Corps of Engineers (Bell 1991) defined three swimming speeds in their fisheries handbook: **cruising**, defined as being maintained for hours; **sustained**, which can be maintained for minutes; and **darting**, which is not sustainable. Bell indicated that the cruising speed of a fish may be about 18% of its darting speed. Bell (1991) recommended that velocities in fish passage facilities must be kept well below fish darting speeds, and partly because fish must swim through at least 50 feet of elevated velocities near the gates.

Batelle Labs (Pearson et. al, 2005) published an excellent report on the leaping ability of juvenile salmon.

### **5.3 Agency Fish Passage Criteria for Depth, Pool Spacing, and Velocity**

There is general agency agreement on the basic design criteria for fish passage and it tends to be very conservative in the absence of species-specific swimming capacity data. This tendency to adopt conservative criteria also protects multiple species and life stages.

The following agency fish passage guidelines were reviewed:

- State of Washington
- State of Oregon
- National Marine Fisheries Service

Note that both Washington and National Marine Fisheries Service are draft guidelines – and have been so for many years, indicating that this is a relatively new field with much additional research needed.

Additionally, information from British Columbia and Alaska passage guidelines were also reviewed.

### **5.4 Fish Passage Guidelines for Culverts**

There are abundant literature and guidelines available on fish passage design criteria for culverts. While specifically related to providing fish passage through culverts, they incorporate many of the design features of interest: depth, velocity, pool spacing criteria for various salmonids, as well as designs using boulder clusters, rock weirs and other natural design features. This information can provide a wealth of information that can be adapted to larger passage projects in tributaries.

### **5.5 Rock Weirs, Boulder Clusters, and Nature-Like Fishways**

The nomenclature for the relatively new concepts in natural fish passage structures is evolving. These natural fishways have been referred to by many names (Wildman et al 2005):

- natural fishways,
- nature-mimicking fishways,
- naturalized fishways,
- semi-natural fishways,
- bypass channels,

## Rock Ramp Design Guidelines

- step-pool fishways,
- riffle-pool fishways,
- pool and weir channels,
- stream-like channels,
- pool-type fishways,
- rock ramp fishways,
- rocky ramps,
- roughened ramps,
- riprap fishways,
- rapids, and
- riffles.

The suggested naming protocol by Wildman et al. seems reasonable and is suggested here for use in Reclamation projects. All of these fishways are referred to as nature-like fishways. This category is divided into two primary subcategories referred to as bypass channels and rock ramp fishways. Bypass channels include all nature-like fishways that are designed to circumvent the stream barrier, while rock ramp fishways include all nature-like fishways that modify the riverbed grade to pass fish within the stream banks.

Nature-like fishways are defined as fishways whose designs are based on simulating natural stream characteristics, use natural materials, and provide suitable passage conditions over a range of flows for a wide variety of fish species and other aquatic organisms.

Wildman et al. provide the following observations:

“The use of nature-like fishways as a viable fish passage alternative is becoming more accepted around the world. Many of these nature-mimicking structures now exist in countries throughout Europe, as well as Australia, Canada and Japan. More recently they have been gaining acceptance in the U.S. The design philosophy for these fishways is simple, ecologically minded, and aims to achieve a good fit with the specific riverine environment they are constructed in. The idea is to observe and apply some of the features of a natural riverine system when designing structures that become part of this system. It makes inherent sense that the designer of any structure should fully understand the system for which they are designed. The design strives to pass a diversity of fish species at varying life stages in the most efficient manner possible but in addition provides suitable aquatic habitat for the many organisms present in a river. Organisms are highly specialized in their habitat requirements. Whether we fully understand river systems or not, every part of a river’s structure plays a critical role in one of the many life stages of the numerous organisms living in a river. It is for this reason that designers of nature-like fishways strive to duplicate the physical features observed in natural river systems adjacent to where fishways may be constructed. We may, as designers, never fully

understand the intricacies and interconnection of the complex riverine environments. However by duplicating them as best we can we help to maintain and create beneficial aquatic habitat”.

The best basic primer on designing natural channels is contained in the book “Fish Migration and Fish Bypasses” by Jungwirth, Schmutz, and Weiss (1998). Seven of the most relevant chapters include chapters 13, 14, 25, 26, 27, 28, and 29. Another useful reference is “An Illustrative Handbook on Nature-Like Fishways” (Wildman et al 2005). This handbook provides an excellent definition of terms and presents 28 cases that illustrate many of the nature-like fishways already constructed.

A good deal of literature is available on the relatively recent trend toward designing more natural appearing fish passage structures. Much of the early work started in Europe in the 1980s. In the US, the eastern seaboard has been the center of most natural fish passage projects. There is scant information on design criteria for natural passage structures. This concept is a relatively new endeavor. However, there is abundant literature available in the form of case studies. One particular article provides an excellent review of ichthyomechanics and the hydraulics of fishways (Katopodis, 1992). This provides a basic understanding of the design considerations for fishways which can be readily adapted to natural fish passage structures.

## **5.6 The Planning Process**

One of the most important concepts to emerge from the literature review is the need to adapt basic designs to fit each site-specific situation (geomorphology, flow regime, biological community). A cookie cutter approach is unlikely to be effective. It is also essential to work closely with local biologists who are knowledgeable of the fish species in the river where fish passage is to be provided.

The most fundamental aspect of planning any fish passage facility is consideration of the species to be passed. Detailed knowledge of the movement, time of spawning and swimming and leaping abilities of each species, as well as any other behavioral traits applicable to passage, are ideally incorporated into the planning and design of a fish passage facility. This information is rarely available especially for non-salmonid species. The lack of information is compensated for by mimicking, to the degree possible, the slope, morphology, and hydraulic conditions of streams in which the fish community is found (Parasiewicz et al. 1998).

There are no design standards as yet for creating nature-like fishways. Parasiewicz et al. recommend proceeding with a foundation of river restoration construction techniques. A starting point for drawing a plan can be a traditional pool-riffle concept then adding irregularity in sequence as found in natural systems. Without relying on specific criteria for pool sizes, some logic should be followed in creating the largest pools either just downstream of the most critical

channel profiles or after a series of runs (flumes). Runs between riffles and pools should have highly variable profiles consisting of a variety of differently sized substrates in combination with woody debris. This variability produces a variety of velocity profiles through which all occurring species can pass at varying discharges.

## 5.7 References

- Beamish, F.W.H. 1978. Swimming Capacity. *In* Hoar, W.S. & D.J. Randall Eds. Fish Physiology, Vol.VII. Academy Press, NY.
- Bell, Milo C. 1991. Fisheries Handbook of Engineering Requirements and Biological Criteria. U.S. Army Corps of Engineers. Fish Passage Development and Evaluation Program. Portland, Oregon.
- Blaxter, J.H.S. 1969. Swimming speeds of fish. *FAO Fish. Rep.* 62 Vol. 2: 69-100.
- British Columbia Ministry of Forestry (2002). Fish-stream crossing guidebook. For. Prac. Br., Min. For., Victoria, B.C. Forest Practices Code of British Columbia guidebook. Online at: <http://www.for.gov.bc.ca/tasb/legsregs/fpc/fpcguide/FishStreamCrossing/FSCGdBk.pdf>
- Geist, D.R., R.S. Brown, V.I. Cullinan, M.G. Mesa, S.P. Vanderkooi and C.A. McKinstry. 2003. Relationship between metabolic rate, muscle electromyograms and swim performance of adult Chinook salmon. *J. Fish. Biol.* 63: 970-989.
- Jungwirth, M., S. Schmutz, and S. Weiss, Editors. 1998. Fish Migration and Fish Bypasses. Fishing News Books. University of Agricultural Sciences, Vienna, Austria.
- Kahler, T.H. and T.P. Quinn. 1998. Juvenile and resident salmonid movement and passage through culverts. Final Research Report, Research Project T9903, Task 96. Fisheries Research Institute, Univ. of Washington, Seattle, WA.
- Katapodis, C. 1992. Introduction to fishway design. Freshwater Institute, Winnipeg, Manitoba.
- NOAA Fisheries (2004). Anadromous Salmonid Passage Facility Guidelines and Criteria (draft document). Online at: [http://www.cbfwa.org/Committees/FSOC/Meetings/2003\\_0304/ReleaseDraftCriteria.doc](http://www.cbfwa.org/Committees/FSOC/Meetings/2003_0304/ReleaseDraftCriteria.doc)
- Oregon Department of Fish and Wildlife (2004). Fish Passage Criteria. Online at: <http://www.dfw.state.or.us/fish/passage/criteria.pdf>
- Parasiewicz, P., J. Eberstaller, S. Weiss and S. Schmutz. 1998. Conceptual guidelines for nature-like bypass channels. *In* Jungwirth et al. eds. Fish Migration and Fish Bypasses. Fishing News Books. Univ. Agricultural Sciences, Vienna, Austria.
- Peak, S. 2004. An evaluation of the use of critical swimming speed for determination of culvert water velocity criteria for smallmouth bass. *Trans. Amer. Fish. Soc.* 133:1472-1479.

- Pearson, W.H., Mueller, R.P., Sargeant, S.L., May, C.W. (2005). Evaluation of Juvenile Salmon Leaping Ability and Behavior at an Experimental Culvert Test Bed. Battelle Pacific Northwest Division, Richland, WA. Prepared for Washington State Department of Transportation, WSDOT Agreement No. GCA2677. June.
- Washington Department of Fish and Wildlife (2000). Fishway Guidelines for Washington State. Online at: <http://wdfw.wa.gov/hab/ahg/ahguides.htm>
- Wildman, L., P. Parasiewicz, C. Katopodis and U. Dumont. 2005 An illustrative handbook on nature-like fishways – summarized version. Online at: [www.americanrivers.org/site/DocServer/Nature-LikeFishwaysHandbook.pdf?docID=202](http://www.americanrivers.org/site/DocServer/Nature-LikeFishwaysHandbook.pdf?docID=202)
- Wildman, L., P. Parasiewicz, C. Katopodis and U. Dumont. 2005 An illustrative handbook on nature-like fishways – summarized version. Online at: [www.americanrivers.org/site/DocServer/Nature-LikeFishwaysHandbook.pdf?docID=202](http://www.americanrivers.org/site/DocServer/Nature-LikeFishwaysHandbook.pdf?docID=202)





## **6.0 Design Event and Lifecycle Costs**

### **6.1 Overview**

The selection of a design event balances the present cost of constructing more resilient structures versus the cost, effort, and likelihood of replacing or repairing weaker structures if a larger flow event occurs. Risk analysis can assist managers in making judgment calls by providing economic costs. Social, regulatory, or habitat perspectives may outweigh costs. In such cases, the economic analysis shows the expense associated with these value based decisions.

Hydrology drives the hydraulic forces that may result in failure of a structure. A design only protects against flows up to a predetermined magnitude. Protecting against larger flow events requires more expensive materials in larger quantities. Smaller, less resilient structures requiring more frequent repairs may result in lower economic costs. Future flow rates cannot be deterministically predicted, but stochastic analysis can describe the likelihood of flow patterns over long time periods at many structures.

The following sub-sections describe methods to determine the probability of design events occurring in a structure's lifetime, the costs associated with maintaining or replacing a damaged structure, and the total lifecycle costs associated with selecting a specific design discharge. The evaluation uses conditions in the Methow Basin, WA as a case study to illustrate the techniques. Values are for illustration purposes only as they represent site specific rough approximations and are not intended to represent a particular site.

### **6.2 Probability of Failure or Maintenance Requirements**

A hydrologic analysis determines the likelihood of occurrence for a given flow rate. The likelihood is typically expressed in terms of a yearly return interval on the maximum annual peak discharge. For example, the 10-year return flow represents the flow rate that has a 1% chance of occurring in any given year. The 10-year event does not occur in a regular or predictable pattern, but can happen in any year or even several years in a row. A binary distribution describes likelihood of experiencing multiple events within a particular time period. The binary distribution can predict the likelihood of the 10-year event occurring 6 times over a 50 year period. Figure 6-1 illustrates an example binary distribution for the number of 10-year recurrence flow over a 50 year time period.

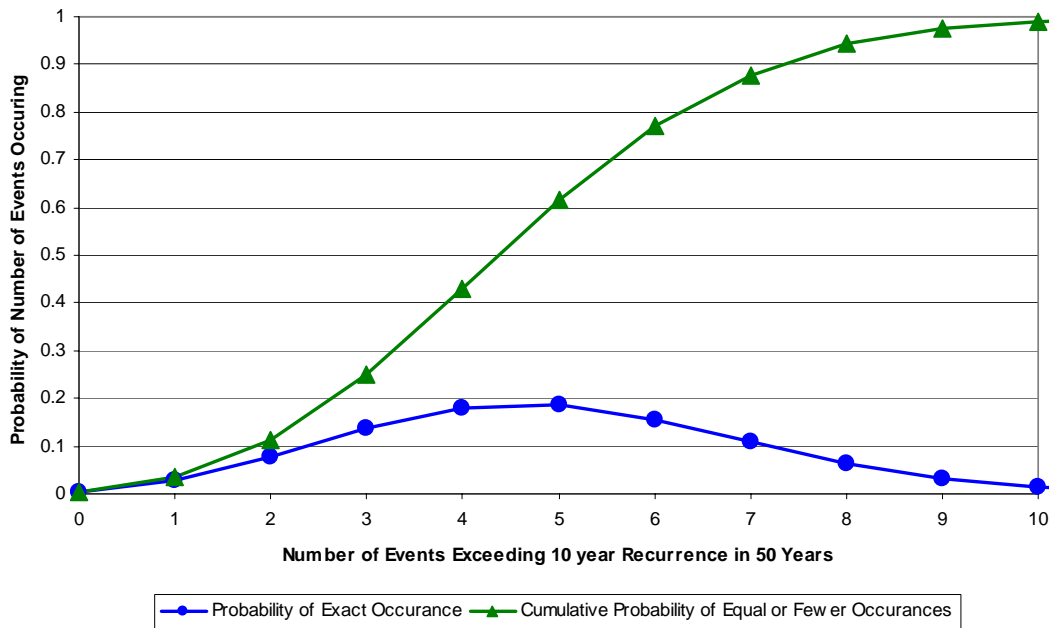

**Figure 6-1 50-Year Lifespan Failure Probability with 10-year Design Discharge**

Following the circles shows the individual probability of a specific number of a particular flow event occurring. Over 50 years, the structure has an 11% chance of experiencing the 10-year flow event exactly 7 times, no more, no fewer. The probability of experiencing the 10-year event exactly 5 times is 18% and is the most likely outcome over the 50 year period. This follows expectations as 50 years divided by a 10 year average occurrence equals 5 events. The triangles show the probability of experiencing the 10-year event no more than a given number of occurrences. It may occur fewer times. There is a 94% chance the structure will experience the 10-year event up to and including 8 times within the next 50 years. Conversely, there is less than a 6% chance the structure would experience the 10-year event more than 8 times. There is a 0.5% chance the structure will never see a 10-year event. The probability of an event meeting or exceeding design discharges represents a risk of repair or replacement requirements for structures over a given time period. The cost to repair or replace a structure is the consequence of that risk.

Figure 6-1 is a general plot applicable across all sites. However, changing the lifespan from 50 years to another time period or changing the recurrence event will result in a different curve. Equation 6-1 shows the equation for computing the binary distribution for a specific number of outcomes.

$$b = \binom{n}{x} \cdot p^x \cdot (1-p)^{n-x} \quad \text{Equation 6-1}$$

$$\binom{n}{x} = \frac{n!}{(n-x)!}$$

Where,

$b$  = probability of exactly  $x$  events occurring in  $n$  years;  
 $x$  = number of events occurring in  $n$  years;  
 $n$  = number of years;  
 $p$  = probability of  $x$  event occurring in a single year (recurrence probability); and  
 $!$  = a mathematical operator called a factorial.

A design event provides input to determine structure dimensions and materials. For rock ramps, the design discharge primarily effects the selection of riprap size and quantity. Riprap sizing methods do not typically estimate a diameter that will obliterate the rock upon exceedance but rather target the beginning of failure and incorporate safety factors for a conservative estimate. A ramp structure will not completely disappear after experiencing a design event. Abt and Johnson (1991) differentiated between beginning of motion and catastrophic movement and found that motion began at 75% of the unit discharge of catastrophic movement. Economic planning can divide lifecycle costs into repair and replacement. Failure to maintain or repair structures will result in a need for subsequent replacement after much lower flows than the design discharge.

Figure 6-2 shows two 50-year lifecycle probability curves side by side assuming a 10-year event will require repair and a 25-year event will require replacing the structure.

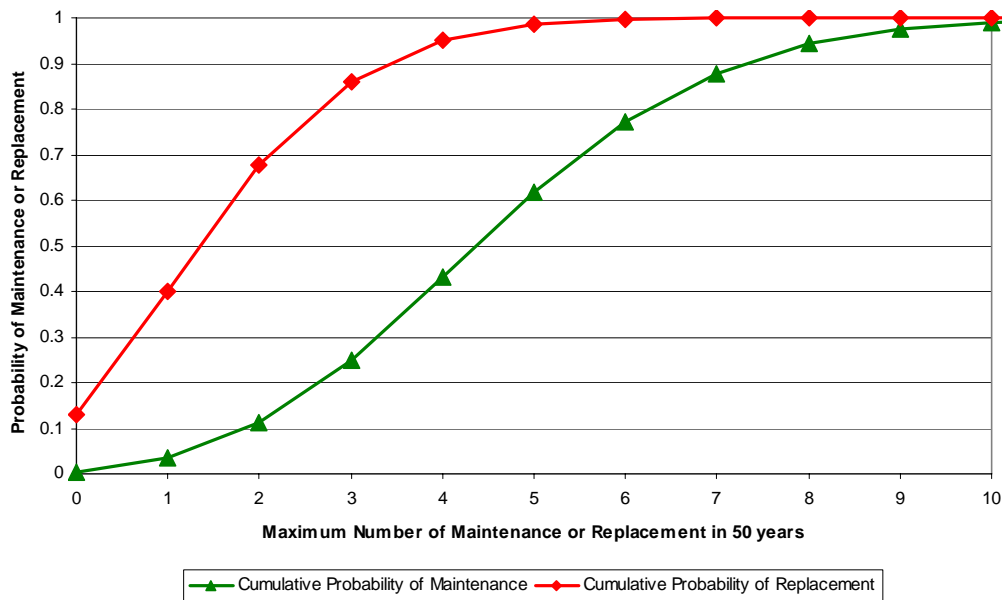

**Figure 6-2 50-Year Maintenance and Replacement Plots Assuming a 10-Year Flood Requires Repairs and a 25-Year Flood Causes a Failure**

For a given probability, a structure will require replacement less often than maintenance. In the example, there is a 40% chance of the structure requiring replacement once or not at all within a 50 year time frame. There is also a 40%

chance the structure would require maintenance 4 times or fewer within a 50 year time frame. There is a 60% chance the structure will require 5 or fewer repairs and 2 or fewer replacements. Both relationships were developed using Equation 6-1, differing only in the recurrence probability, and apply to all sites for the same lifecycle, maintenance probability, and failure probability.

This analysis neglects changes in water use, global climate shifts, and morphologic adjustments which change repair or replacement probabilities. This analysis neglects temporal and spatial correlation by assuming independent outcomes. Climatic patterns tend to cluster temporally where a series of wetter years follows a series of dryer years in cyclic patterns. Structures in the same or nearby basins should show similar flow patterns. The 50-year event would likely occur over a significant portion of a basin rather than a single structure. More advanced hydrologic analysis is possible, but is beyond the scope of these design guidelines. With many structures over large areas and long time frames the significance of the correlation decreases. However, longer time frames increase the importance of water usage trends, climate change, and morphologic adjustment.

Design practices incorporate safety factors to account for the unknown. The use of safety factors increases the resilience of structures. In theory, structures should require maintenance and replacement less often than predicted. Practically, the increased resilience cannot be relied upon and unforeseen circumstances can reduce the lifespan in an unquantifiable manner. Improper or inadequate design and construction can increase the replacement and maintenance rate. The economic evaluation assumes proper and precise design and construction.

### **6.3 Costs of Replacement and Maintenance**

Costs vary from site to site depending on expertise and availability of labor and materials. The design discharge impacts the volume of riprap required and, to a lesser extent, the unit cost of riprap through size changes. Large design flows require larger and more expensive riprap diameters. Larger riprap diameters require thicker layers. Up to a certain diameter, the unit cost remains relatively constant and additional material expenses occur primarily through increased volume requirements. Costs of repair or replacement of a structure include mobilization and administrative efforts, labor, materials, and permits. Table 6-1 shows a site specific cost example using a 24-in.  $D_{50}$  diameter as a base and representing all other factors as a scalar. Unit costs were estimated with the assistance of the economic group within the Technical Service Center. Values represent estimates not actual prices and should not be applied to actual designs.

**Table 6-1 Hypothetical Riprap Costs by Diameter**

Design Event (years)	Median Diameter (in.)	Fraction of 24-in. Unit Costs	Fraction of 24-in. Volume	Fraction of Material and Labor Costs
2	12	0.94	0.5	0.47
5	18	0.96	0.75	0.72
10	21	0.98	0.875	0.8575
25	24	1	1	1
50	36	1.5	1.5	2.25
100	48	2.5	2	5

Figure 6-3 shows a site specific example applying the riprap costs for various design events. The plot represents a site specific hypothetical case and should not be applied to actual projects. Each project would generate unique plots.

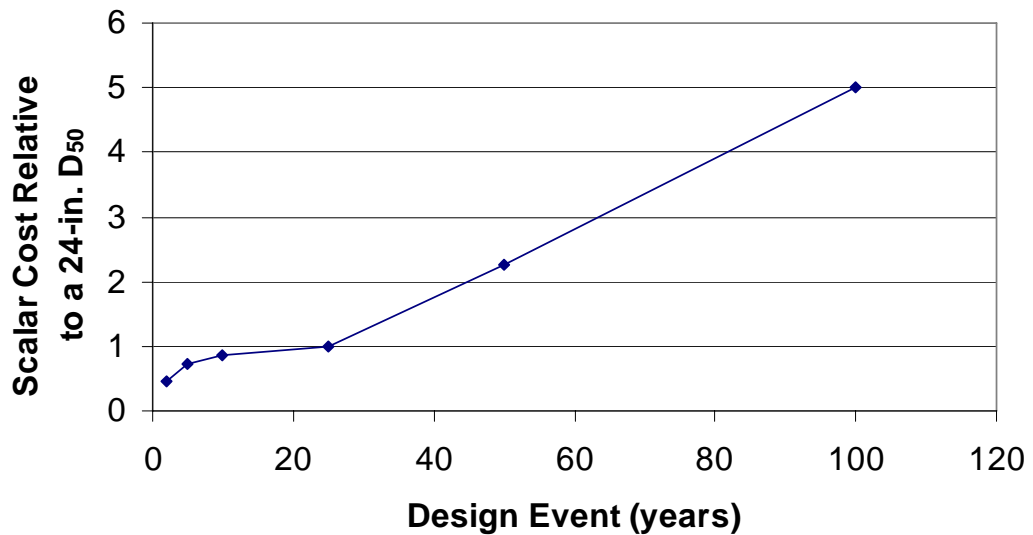

**Figure 6-3 Riprap Cost as a Function of Design Event**

Material for a 50-year event design discharge costs three times as much rock for a 5-year event. Practical considerations may limit the type of material called for in the design as availability and equipment capabilities restrict options. The cost of repairing a structure may be considered as a fraction of the replacement cost and depend on the extent of damage. 50% represents the median value. Mobilization and contingency are estimated to run 7.5% of the total cost and are scaled uniformly across the entire project. The as placed cost accounts for labor.

## 6.4 Total Lifecycle Costs

Descriptions for the likelihood of a specific number of times for repair and replacement of an individual structure report discrete integer values. Design event alternatives should use a common probability for comparison. The 50%

repair and replacement probability can be compared for different design events. So can the 90% probability. There is little meaning in comparing a 90% probability for a 10-year event with a 50% probability for a 25-year event. Comparing across common probabilities no longer results in discrete integer values. A manager must act in whole units and cannot repair a structure 1.34 times. Fraction values can be interpreted as if many structures were present and each required a replacement an average of 1.34 times.

The analysis represents a present value analysis of the project. The federal discount rate adjusts the future costs of repair and replacement to today's dollars. Delaying costs to the future represents a savings in the present value. Reporting all amounts in present day dollars allows for a time unit for comparison. Equation 6-2 shows the reduction in cost represented by deferred costs according to a discount rate,  $i_d$ .

$$Discount = \frac{1}{(1 + i_d)^n} \quad \text{Equation 6-2}$$

Where,

Discount = future value of a structure after n time periods;

$i_d$  = inflation rate used for projecting costs forward in time; and

n = number of compounding periods.

Assuming a 5 percent federal discount rate, a 9,000 dollar repair effort 20 years into the future is discounted 37.7 percent for a present value of 3,390 dollars.

For the purpose of comparison, maintenance and replacement of a structure is assumed to take place at evenly spaced intervals. The total cost for a 20-year lifespan with a structure installed once, replaced once after the  $Q_{10}$  design flow, and repaired twice after two  $Q_5$  floods would require the initial cost, plus a discounted replacement cost, plus discounted repair costs. Table 6-2 shows the calculations for a structure costing \$10,000 to construct and \$5,000 to repair over a 20-year lifespan assuming a 4% discount rate.

**Table 6-2 Lifespan Present Value Cost Estimate**

Return Year (years)	Cost (dollars)	Discount (ratio)	Present Value (dollars)
<b>0</b>	<b>\$10,000</b>	<b>1.00</b>	<b>\$10,000</b>
1	\$0	0.96	\$0
2	\$0	0.92	\$0
3	\$0	0.89	\$0
4	\$0	0.85	\$0
<b>5</b>	<b>\$5,000</b>	<b>0.82</b>	<b>\$4,110</b>
6	\$0	0.79	\$0
7	\$0	0.76	\$0
8	\$0	0.73	\$0
9	\$0	0.70	\$0
<b>10</b>	<b>\$10,000</b>	<b>0.68</b>	<b>\$6,756</b>
11	\$0	0.65	\$0
12	\$0	0.62	\$0
13	\$0	0.60	\$0
14	\$0	0.58	\$0
<b>15</b>	<b>\$5,000</b>	<b>0.56</b>	<b>\$2,776</b>
16	\$0	0.53	\$0
17	\$0	0.51	\$0
18	\$0	0.49	\$0
19	\$0	0.47	\$0

The total cost for selecting a 10-year design event is \$23,642. Other design flows may result in greater or smaller costs.

The total cost of installing a structure at a site for a given time period depends on the number of times it will require repair or replacement. Figure 6-4 shows the dimensionless costs of structures designed with different repair and replacement return periods for an 80% chance that costs will be equal to or less than the plotted values.

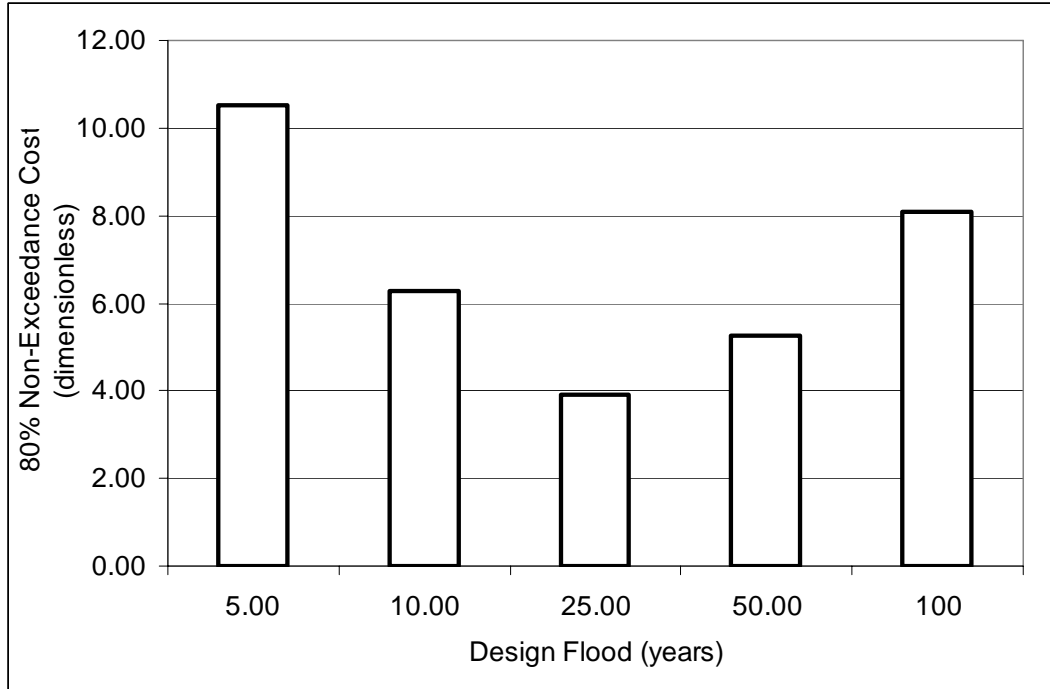

**Figure 6-4 Design Event versus 80% Non-Exceedance Probability Cost for 50-Year Design Life**

Figure 6-4 performs a present value analysis using the number of times a structure requires repair or maintenance and the cost for the repair or maintenance over a 50 year design life. A 25-year design event provides the most economical balance between designing more expensive robust structures versus cheaper weaker structures. Managers can be 80% certain that the non-dimensionalized cost will not exceed 3.9.

Social, budgetary, or environmental values may dictate other alternatives and the economic analysis quantifies the dollar cost of those values. The cost of a failed structure in inability to meet customer demands may outweigh the construction economics. The loss of land due to failed stabilization may be deemed unacceptable. Those costs can and should be included in the analysis in addition to material and labor costs.

## 6.5 Lifecycle Cost Estimation Steps

The following steps will determine the lifecycle costs for different design events.

1. Size riprap and determine quantities for a range of design events.
2. Compute the total structure cost for different design events.
3. Compute lifecycle costs for different design events over a range of probabilities
4. Incorporate value based criteria to present risks and costs for a management decision on the design event.



The most economical decision may not meet management objectives. Step 4 incorporates other objectives to determine the cost considerations beyond economics.

## **6.6 Summary**

The stochastic description for the likelihood of a structure requiring repair or replacement provides a means of estimating the lifecycle costs associated with a design event. Probability expresses the likelihood of a particular design event requiring an equal or lesser lifecycle cost. The counter probability expresses the likelihood of the lifecycle costing more. Multiple structures designed under different and independent recurrence events can be integrated using a common probability.

Some structures may form critical infrastructure while others may be easy to repair or replace. This methodology does not account for lost delivery opportunity and assumes all structures must be maintained.

Use of the analysis requires understanding that statistics do not predict absolutes and any given region or group can get lucky or unlucky. Long time frames with broad spatial perspectives are required for the calculation to bear out. Monitoring and tracking repair and replacement can provide information not only to improve construction methods, but cost estimates as well.



## 7.0 Boulder Clusters and Isolated Rocks

### 7.1 Overview

Isolated rocks or boulder clusters, sometimes called fish rocks, consist of flow obstructions placed in a stream to modify local hydraulic conditions, create scour holes, and induce deposition. These features can be placed within rock ramps or on their own. Design objectives that might call for isolated rocks include;

- Velocity Diversity;
- Depth Diversity (pool habitat);
- Substrate Diversity; and
- Energy Dissipation.

Velocity diversity consists of local zones of flow acceleration alternating with eddies. Bed and depth diversity occurs through local scour around the base of the stone. The structures may induce gravel deposition downstream. Drag and eddy formations created through obstructing the flow create energy losses. Table 7-1 lists some advantages and disadvantages to installing isolated rocks or boulder clusters in a stream.

**Table 7-1 Boulder Placement Advantages and Disadvantages**

<b><i>Advantages</i></b>	<b><i>Disadvantages</i></b>
<ul style="list-style-type: none"><li>• Low material cost</li><li>• Low maintenance</li><li>• Source of cover</li><li>• Provide resting areas</li><li>• Natural aesthetics</li></ul>	<ul style="list-style-type: none"><li>• Labor intensive construction</li><li>• Potential bank destabilization</li><li>• Potential bed destabilization</li><li>• Potential boating safety hazard</li><li>• Potential upstream bar formation</li><li>• Should be placed in the wet to observe flow patterns and eliminate extensive dewatering</li></ul>

After comparing the advantages and disadvantages of boulders compared to other alternatives and determining the desirability, the site specific conditions should be compared to the range of applicability. After determining the desirability, applicability, and desired hydraulic condition to create from boulder clusters a designer must identify the following parameters:

- Boulder Dimensions;
- Planform Placement; and
- Embedded Depth.

Methods for design and evaluation of isolated rocks are not well established. The following sections summarize the applicable uses, placement, hydraulic effects and resultant scour potential, as well as the current best practices identified through literature review.

## 7.2 Range of Applicability

A literature review did not identify consensus on the applicable range of use for boulder clusters. Some of the decision criteria found in the search included:

- Morphology
- Ice and Debris
- Substrate
- Gradient
- Velocity

Boulder installations have the potential to increase bank failure. Installation should occur only in areas with stable banks (Taccogna and Munro 1995, Fischenich and Seal (1999). Fischenich and Seal (1999) further recommend installations only in single threaded channels. WDFW (2004) cautions against installation in incised channels due to the potential to cause lateral migration.

Ice and debris can catch on isolated rocks and create jams that increase the upstream water surface elevation or dislodge the rocks. Isolated or clustered rocks can modify the plan layout and protrude into the flow. Design modifications to account for ice and debris passage may include limiting the height of the protrusion or designing a planform layout to avoid creating debris obstacles. Designers may want to consider other structural and non-structural methods under conditions with heavy ice and debris loads.

The substrate specifies the size of material comprising the bed of the channel. Construction on material too fine results in excessive scour and the boulder “sinking” into the bed. Therefore, sand channels are inappropriate. Installing isolated rocks or clusters in very large material minimizes the benefits. Bedrock channels cannot create scour pools but may induce gravel deposition. The literature specifies gravel and cobble bed streams only (Taccogna and Munro 1995, Fischenich and Seal 1999). High sediment loads may surround and burry boulders (Ward 1997).

Applicable gradients where rock installs can be used include a large range of values. Table 7-2 summarizes the ranges recommended in the reviewed literature.

**Table 7-2 Applicable Range of Gradients for Isolated or Clustered Rocks**

<b>Gradient</b>	<b>Source</b>
< 3%	Taccogna and Munro (1999)
Moderate	Alberta (2001)
0.5 to 1% for Spawning Enhancement 1 to 4 % for Rearing / Cover	Flosi et al.(1998)

From a morphologic standpoint, alluvial channels with slopes below 1% may consist of sandy substrates where boulder clusters will not remain in place but rather sink into the bed. Channels over a gradient of 5% typically exhibit step-pool morphology where boulder clusters are unlikely to be stable. High gradient sites should consider step pools rather than boulder clusters. The range of

applicable gradients acts as a surrogate for velocity. Table 7-3 shows the range of applicable velocities recommended in the literature review where designers may wish to consider boulder clusters.

**Table 7-3 Applicable Ranges of Velocities for Isolated or Clustered Rocks**

<b>Velocity (ft/s)</b>	<b>Source</b>
> 4	Fischenich and Seal (1999)
> 2	FISRWG (10/1998)
> 2	Seehorn (1985)
2 - 8	Alberta (2001)
< 8	FHWA (1979)

A designer should evaluate the range of criteria listed below with respect to the specific project goals. Elements to consider include:

- Required Stable Rock Diameter
- Potential Scour Depths
- Effects on the Velocity Field
- Potential for Bank Erosion

If a designer determines boulders might fulfill a project objective, the analysis process will assist in narrowing the applicability requirements. The following design questionnaire presents some methods for determining the applicability of isolated rocks and boulder clusters:

1. Is the existing or proposed velocity, depth, or amount of cover undesirable?
2. Is the bed material gravel or cobble?
3. Is the channel single threaded?
4. Is the channel stable in profile?
5. Are the banks stable?
6. Are ice and debris flows insignificant?
7. Is the required rock diameter possible to obtain and install?
8. Does the required stable rock diameter or proposed boulder cluster placement obstruct too much flow?
9. Is the change in water surface elevation acceptable?
10. Is the predicted scour pool depth caused by the rock acceptable?
11. Are the predicted local depth and velocity conditions after boulder installation desirable?

An affirmative answer to all the applicability questions suggests isolated rocks or boulder clusters would provide a sustainable method of meeting project objectives.

### 7.3 Shape and Sizing of Isolated Rocks

The size of an isolated rock must be large enough to simultaneously resist movement as well as create the desired hydraulic conditions. Several authors provided guidelines for the shape and sizing of isolated rocks. Though not specific to site conditions, the numbers can provide a check on calculations.. Alberta (2001) recommends diameters in the range of 60-90 cm. Mefford (2005) recommends 4 ft rocks. FHWA (1979) provided Table 7-4 for sizing rocks.

**Table 7-4 Boulder Diameters For Normal Summer Flow (FHWA 1979)**

<b>Channel Width (ft)</b>	<b>Bankfull Flow Depth(ft)</b>	<b>Rock Diameter (ft)</b>
<20	1.0-2.5	2-4
20-40	1.0-3.0	3-8
40-60	1.5-4.0	4-12
>60	1.5-5.0	5 +

Incipient motion can determine the likely flow required to move an isolated rock. Critical shear stress, Shields parameter, or stream power methods provide an empirical approach to sizing rocks. Julien (1999) describes shear stress and Shields parameter approaches while Yang (1973) describes the stream power approach. Fischenich and Seal (1999) recommend using incipient motion for an initial size and then performing a momentum balance to determine the required diameter of the rock to resist motion. Equation 7-1 shows the force balance to resist rolling and incorporates downward secondary currents on the outside of a bend. Sliding motion, such as with bedrock, or upward secondary currents (inside of a bend) require different equations. The balance assumes proportional lift and drag forces in order to eliminate rock dimensions from the relationships.

$$SF = \frac{a_{\theta} \cdot \tan(\phi)}{\eta_1 \cdot \tan(\phi) + \sqrt{1 - a_{\theta}^2} \cdot \cos(\beta)} \quad \text{Equation 7-1}$$

$$a_{\theta} = \sqrt{\cos^2(\theta_1) - \sin^2(\theta_0)}$$

$$\theta = \tan^{-1}\left(\frac{\sin(\theta_0)}{\sin(\theta_1)}\right)$$

$$\eta_1 = \eta_0 \left[ \frac{\left(\frac{A}{B}\right) + \sin(\lambda + \beta + \theta)}{1 + \left(\frac{A}{B}\right)} \right] \cong \eta_0 \left[ \frac{1 + \sin(\lambda + \beta + \theta)}{2} \right]$$

$$\eta_0 \cong \frac{18 \cdot \tau_0}{(\gamma_s - \gamma_w) \cdot D_s}$$

$$\beta = \tan^{-1} \left( \frac{\cos(\lambda + \theta)}{\frac{(A + B) \cdot \sqrt{1 - a_0^2}}{B \cdot \eta_0 \cdot \tan(\phi)} + \sin(\lambda + \theta)} \right) \cong \tan^{-1} \left( \frac{\cos(\lambda + \theta)}{\frac{2 \cdot \sqrt{1 - a_0^2}}{\eta_0 \cdot \tan(\phi)} + \sin(\lambda + \theta)} \right)$$

$$A = \left( \frac{l_4}{l_2} \right) \cdot \left( \frac{F_L}{F_S} \right)$$

$$B = \left( \frac{l_3}{l_4} \right) \cdot \left( \frac{F_D}{F_S} \right)$$

$$\frac{A}{B} \approx 1$$

Where,

SF = Safety factor;

$D_s$  = rock diameter;

$\theta_0$  = longitudinal bed slope;

$\theta_1$  = bank side slope;

$\phi$  = Angle of repose ( $\cong 42$  Degrees);

$\lambda$  = angle of vertical stream line deviation from horizontal, must be  $\geq 0$   
(outside of a bend);

$\tau_0$  = bed shear stress =  $\gamma \cdot R \cdot S_f$ ;

$\gamma$  = unit weight of water;

R = hydraulic radius;

$S_f$  = friction slope;

$\theta$  = down-slope angle including bed and bank slope;

$\eta_0$  = shear force acting on the rock;

$\beta$  = correction for side slope, bed slope, and secondary currents;

$\eta_1$  = correction for side slope, bed slope, and secondary currents; and

$l_{1,2,3,4}$  = moment arms between riprap particles (canceled through lift and drag assumptions).

A, B = lever arm ratios. The ratio A/B is assumed to equal 1.

Rock ramp installations should use the momentum balance and can assume negligible secondary currents because they should be installed only in the straight part of a reach. Empirical methods such as Shields or stream power should be used to provide a check on the reasonability.

## 7.4 Planform Placement of Isolated Rocks

The plan-view placement of rocks can alter scour and deposition patterns and increase energy losses. Fish passage criteria may influence the spacing. Cluster planform placement requires the following elements:

- Morphologic Location
- Cluster Configuration: Individual placement or group configuration
- Lateral Location
- Degree of Obstruction
- Orientation to the flow
- Lateral and Longitudinal Spacing

The following subsections describe the characteristics reported in the literature and synthesize the review to develop design guidelines.

### 7.4.1 Morphologic Location

The location of the rock placement with respect to a pool, riffle, or glide morphologic features can improve or degrade the performance of boulder clusters. A boulder cluster should not be installed in pools. Ward (1997) warns that installations in the upper half of a riffle will cause aggradation and diversion. Table 7-5 reports the recommended locations.

**Table 7-5 Recommended Morphologic Location**

<i>Location</i>	<i>Source</i>
Away from pools and slow runs and at least 16 feet downstream of the head of a riffle.	Fischenich and Seal (1999)
No restriction	FISRWG (10/1998)
Riffles, glides, and shallower runs	Alberta (2001)
Bottom half of a riffle	Ward (1997)

Ramps will be treated as artificial riffles but morphologic location does not strongly apply to rock ramp criteria. The objective of specifying applicable morphologic location is to target acceptable depths and velocities where the structure will perform well. Rock ramp locations will be selected on the basis of needs (such as irrigation diversion) while noting Ward’s (1997) recommendation to avoid placing boulders at the top of the ramp. Boulder clusters appear to work best in straight homogenous reaches. Other locations likely have enough depth and velocity diversity.

### 7.4.2 Intra-cluster Configuration and Interstitial Spacing

Using clusters of rocks rather than single isolated elements creates more depth and velocity diversity by amplifying the hydraulic disruption. Other advantages of rock clusters include greater stability, redundancy, and more utilization by fish. FISRWG (10/1998) recommends placing rocks in groups of 3 in the shape of a “V” pointed either upstream or downstream. Alberta (2001) emphasized that upstream or downstream Vs provide different scour pool shapes. Ward (1997) recommends groupings of 5 to 7. King County (1993) includes a diagram of rock



shapes and the expected scour and deposition patterns. Mefford (2005) recommends upstream pointed “V”s when used in ramps.

The recommended distances between rock clusters varies from 6 inches to 4.8 feet. The disparity reflects the ambiguity between spacing isolated rocks versus rocks in a cluster. Mefford (2005) recommends a cluster of 3 in an upstream pointed chevron with arm angles 60 degrees from the downstream direction of flow. His criteria were specifically developed for rock ramps and an intra-cluster spacing of 1 to 1.5 feet is recommended. The hydraulic impacts of an obstruction extend beyond the physical boundary. Intra-cluster interstitial spacing (distance between rocks) attempts to create further diversity by overlapping and interfering hydraulic effects from multiple rocks. Table 7-6 shows the range of criteria in the literature.

**Table 7-6 Intra-Cluster Configuration and Interstitial Spacing**

<b><i>Intra-Cluster Spacing</i></b>	<b><i>Source</i></b>
6 in. to 1ft	FISRWG (10/1998)
0.8 to 1.5 m spacing between boulders	Alberta (2001)
<1.1 Rock Diameter for a Cluster, > 1.8 for independent	Albers et al. (1998)
Groups of 3	Alberta
0.5 to 1 m	Ward (1997)
1 to 1.5 feet	Mefford (2005)
6 inches to 3 feet	WDFW (2004)

The dimensions of the low-flow channel may preclude the configurations recommended in the literature or using multiple rocks. Ramp designs may use isolated rocks and the boundary of the low flow channel to create similar hydraulic effects. Ramp installations will minimize scour dimensions and are unlikely to induce deposition. Hydraulic criteria will control the configuration.

### **7.4.3 Flow Obstruction**

The degree of obstruction specifies the amount of area blocked by the physical dimension of the rock. The hydraulic obstruction is greater than the physical dimensions of the rock clusters due to added wetted perimeter. A review of literature identified the criteria shown in Table 7-7.

**Table 7-7 Obstruction Criteria**

<b><i>Obstruction Width (Percent of Bankfull Width)</i></b>	<b><i>Source</i></b>
< 10%	Fischenich and Seal (1999)
< 20%	FISRWG (10/1998)
20%	FHWA (1979)
< 33%	Oregon State Highway Division (1976)
20% to 30%	WDFW (2004)

Obstruction criteria are primarily concerned with maintaining conveyance and avoiding channel destabilization. Such constraints do not directly apply to rock ramps. At the extreme, blocking the entire channel width will create a step-pool system which may require fish to jump. Ramp design can set the degree of

obstruction according to allowable velocities determined through the hydraulic impact section.

#### 7.4.4 Longitudinal Spacing

The longitudinal spacing determines the number of structures in a channel. The Province of Alberta (2001) recommends numerous small structures to improve habitat for young fish and larger sparse layouts to improve habitat for older fish. Table 7-8 lists recommended spacing criteria reported in the literature.

**Table 7-8 Longitudinal Spacing**

<b>Obstruction Spacing</b>	<b>Source</b>
1/3 of the stream width	Fischenich and Seal (1999)
>2.5 m	Alberta (2001)
1 Rock per 300 ft <sup>2</sup>	FHWA (1979)
3 m	Ward (1997)
10 – 12 feet	WDFW (2004)

Spacing will be based on hydraulic properties according to required resting and dart distance of the target species and age. Acharya (2000) found the velocity recovered to 75% of the free stream at a distance of 8 times the rock diameter for subcritical flow. Supercritical flow recovered within a distance of twice the diameter. Acharya recommended a longitudinal spacing of 4 times the median diameter. Mefford (2005) recommends spacing based on water surface drop across each structure.

#### 7.4.5 Lateral Location

Boulder clusters should be located in the center of the channel away from the banks where they are unlikely to direct flow into a bank. Multiple structures should be staggered. The acceptable range varies from centering the rocks to placement within the middle ¾ of the channel. Table 7-9 shows the range of criteria reported in the literature.

**Table 7-9 Lateral Location**

<b>Lateral Location</b>	<b>Source</b>
Thalweg of the channel	Fischenich and Seal (1999)
Middle half of the channel	FISRWG (10/1998)
Middle ¾ of the Channel	Alberta (2001)
Thalweg of the Channel	FHWA (1979)

In a rock ramp installation, the narrow width of the low-flow channel will likely preclude lateral locations mimicking natural channels. The lateral location will likely lie in the center of the low flow channel or slightly staggered. The rocks may be positioned against alternating walls in the manner of a deflector if alternating side to side currents are desirable. Acharya (2000) recommended a lateral spacing of isolated rocks equal to 3 times the diameter to maximize the interference between multiple rocks.

## 7.5 Hydraulic Impacts

Isolated rocks impact the hydraulics through the obstructed area and introduce additional energy losses through eddy formation, flow contraction, and flow expansion. When the obstructed area is small relative to depth, boulder clusters can be simulated through an increase in channel roughness. At a local scale, isolated rocks create eddies and local flow conditions much different than average cross section characteristics. Analysis of these local flow characteristics requires methods outside of 1D hydraulic modeling. Hydraulically, isolated rocks behave similar to bridge piers.

### 7.5.1 Isolated Rock Simulation through Added Roughness

FHWA (1979) computer studies present the increase in Manning's  $n$  value over 0.035 for water flowing at 5ft of depth with 5 ft rocks placed in a 50ft long reach of stream. Table 7-10 shows the relative increase in roughness from the studies.

**Table 7-10 Relative Increase in Manning  $N$  values**

Number of Rocks	Width (feet)			
	50	40	60	100
1	4	3	2	7
4	15	12	8	6
7	25	20	15	10

Mefford (2005) performed a flume study for upstream pointed chevron patterns and recommended roughness values as a function of submergence with  $n = 0.09$  around 100 percent submergence down to 0.050 above 110 percent submergence.

### 7.5.2 Isolated Rock Simulation via Bridge Pier Techniques

The HEC-RAS (Bruner 2002) backwater model provides several methods for simulating energy losses around bridge piers, including using empirical coefficients. Either the momentum or Yarnell approach will work equally well. HEC-RAS can be used to simulate rock clusters as bridge piers with a bridge deck higher than the water surface elevation. No guidelines or analytic approaches are available for setting ineffective flow areas upstream and downstream of boulders as per the bridge modeling approach recommended in the HEC-RAS hydraulic reference manual.

### 7.5.3 Local Flow Characteristics

1D hydraulic modeling cannot capture the local hydraulics around boulders or boulder clusters. Physical or multi-dimensional numerical modeling is required to determine specific velocity conditions created around a boulder. One dimension analysis is adequate when the design can accept a high level of uncertainty.

## 7.6 Embedded Depth and Scour

Scour around a boulder increases the depth locally and creates hydraulic diversity. The formation of a scour pool can also undermine placed rocks and

cause them to roll into the hole. Continued scour pool formation and rolling of the rock can lead to sinking and burying of the rocks. To prevent partial or full loss of a rock, the boulder should be embedded to a depth greater than the anticipated scour.

### 7.6.1 Recommended Values

No quantitative scour studies around boulder clusters were identified in the literature, however the processes should resemble scour around bridge piers. Several authors recommend depths but do not specify the rationale or background behind the reported values.

Reports on isolated rock or boulder clusters lack quantitative information on scour. The Washington Department of Fish and Wildlife, WDFW, (2004) recommends embedding to maximum scour at the initial submergence. Mefford (2005) recommends embedding at 20% to 30% of the diameter. The Federal Highway Administration, FHWA, (1979) recommends embedding rock deflectors a minimum of 2 ft. High flows should overtop to clear debris if flooding is a concern (King County, 1993)

### 7.6.2 Boulder Specific Testing

Cullen (1989) tested artificially constructed boulders in a laboratory flume and found the maximum scour depth occurs below the upstream face. Cullen describes the embeddedness of the rock in terms of the percent of the total height exposed to flow. Three exposures were tested, 50%, 75%, and 100%. Boulder length to width ratios of 1, 2, and 4 were tested versus angles of the major axis of the rock to the primary flow direction with right hand rule positive equal to 0, 30, 45, 60 and 90 degrees. The testing setup clear water conditions with no bedload movement on a substrate with a 4 mm  $D_{50}$ . Cullen developed a framework for dimensional analysis but never followed through. Fisher and Klingeman (1984) report relationships from flume tests. Cullen (1989) used the same relationships but fit new coefficients to develop Equations 7-2, 7-3, and 7-4.

$$\frac{y}{h_s} = 0.31 \cdot Fr^{-2.61} \quad \text{Equation 7-2}$$

$$\frac{h_s}{h_r} = 0.81 \cdot \left( \frac{V_s}{V_r} \right)^{0.36} \quad \text{Equation 7-3}$$

$$V_s = 9.92 \cdot h_s^{2.601} \quad \text{Equation 7-4}$$

Where

$y$  = flow depth;

$Fr$  = froude number;

$h_s$  = maximum depth of scour measured from the original bed to the lowest point in the scour hole;

$h_r$  = height of the rock;

$V_s$  = volume of scour; and

$V_r$  = volume of rock.

Cullen did not run the tests to equilibrium but assumed a logarithmic approach which requires multiplying the volume of scour by 1.5. The tests did not incorporate gradation effects.

Lere (1982) measured trout populations on the St. Regis River and found pools on the boulders had a maximum depth of 0.62 m (st dev of 0.14). River properties included a mean width = 6.7 m (st dev of 1.3), mean depth = 30.7 cm (19.1), mean thalweg depth = 53.0 cm (14.1), mean thalweg velocity = 0.53 m/s (0.26), pool-riffle periodicity = 6.3, gradient = 0.0157, and sinuosity = 1.03. Bed material consisted of boulders > 26 cm = 56.90% (20.37), rubble 6.4-26 cm = 32.93% (16.56), gravel 2.0mm-6.3 cm = 8.45% (8.87), and fines <2.0mm = 1.72% (3.53).

### 7.6.3 Clear Water Pier Scour

Isolated rocks create a horse-shoe vortex. The maximum depth of scour occurs during high flow conditions represented by a design event. The design event should meet or exceed the design event for the ramp or reach. Designing for a scour event lower than the ramp design event will create a hole in the ramp and may fail the material prematurely. The riprap layer should be thickened to the depth of scour or installed with a preformed scour hole. None of the pier scour methods account for the impact of multiple rocks in clusters. The following methods follow the HEC-18 methodology (Richardson and Davis 1995) for scour at bridges.

The formation of a horseshoe vortex will remove material from the upstream face and sides of the boulders. Equation 7-5 shows the CSU equation for pier scour.

$$y_{s,p} = 2.0 \cdot K_1 \cdot K_2 \cdot K_3 \cdot K_4 \cdot a^{0.65} \cdot y_1^{0.35} \cdot Fr_1^{0.43} \quad \text{Equation 7-5}$$

Where,

$y_{s,p}$  = depth of scour (ft, m);

$K_1$  = correction factor for shape;

$K_2$  = correction factor for angle of attack;

$K_3$  = correction factor for bed condition;

$K_4$  = correction factor for armoring of bed material;

$a$  = pier width (ft, m)

$y_1$  = flow depth upstream of the obstruction (ft, m); and

$Fr_1$  = Froude number directly upstream of the obstruction.

Evaluating scour around isolated rocks or boulder clusters does not require the consideration of abutment processes or contraction scour included in bridge design techniques.

## 7.7 Impact on Rock Ramps

The presence of large elements within the rock ramp creates a discontinuity in the protective riprap layer. The element will increase both turbulence and local velocities and will create a hole in the riprap layer unless countermeasures are taken. The elements dissipate energy and create eddies. Increases in local velocity may require larger stones on the banks.

## 7.8 Design Steps

Incorporating boulder clusters requires developing the boulder plans as well as revising the initial rock ramp design. Boulder clusters design includes the following steps:

1. Determining the applicability
2. Sizing the rocks
3. Determining cluster configuration, lateral, and longitudinal placement
4. Computing scour hole dimensions
5. Revising the rock ramp design

The feasibility and overall objectives of the rock ramp should be reevaluated after incorporating boulder clusters to determine if a rock ramp is still the most effective and desirable means of meeting project goals.

## 7.9 Design Example

Assuming boulder clusters are desirable, the design example will consider a rock ramp with a triangular 2.5:1 low-flow channel 2 feet deep and 10 feet wide at a slope of 0.03 feet/foot. The high-flow channel is trapezoidal with a hydraulic radius of 3 feet. At the design discharge, the hydraulic radius is 5 feet. The riprap blanket has a 24-inch  $D_{50}$ . The size of a stable rock using the momentum balance is computed as follows:

1. An initial guess of the rock diameter,  $D_s$ , was 3 ft, and developed assuming 3 rocks in the channel with a 0.5-foot spacing between each rock after Mefford (2005). Stone unit weight was assumed to be 165 lb/ft<sup>3</sup>. Equation 7-1 is used to determine the factor of safety, SF.

$$\eta_0 \cong \frac{18 \cdot \tau_0}{(\gamma_s - \gamma_w) \cdot D_s}$$

$$\eta_0 \cong \frac{18 \cdot \gamma_w \cdot R \cdot S_f}{(\gamma_s - \gamma_w) \cdot D_s}$$

$$\eta_0 \cong \frac{18 \cdot (62.4 \text{ lb/ft}^3) \cdot (5\text{ft}) \cdot (0.03 \text{ ft/ft})}{(165 \text{ lb/ft}^3 - 62.4 \text{ lb/ft}^3) \cdot (3\text{ft})}$$

$$\eta_0 \cong 0.547$$

2. Assuming parallel streamlines,  $\lambda = 0$  and no side slope,  $\theta_1 = 0$ . The bed slope must be converted from a ratio to an angle.

$$\theta_0 = a \tan(S_0)$$

$$\theta_0 = a \tan(0.03)$$

$$\theta_0 = 1.7184$$

$$\theta = \tan^{-1} \left( \frac{\sin(\theta_0)}{\sin(\theta_1)} \right)$$

$$\theta = \tan^{-1} \left( \frac{\sin(1.7184^\circ)}{\sin(0)} \right)$$

Dividing by zero equals infinity and the arctangent of infinity is 90 degrees.

$$\theta = 90^\circ$$

$$a_\theta = \sqrt{\cos^2(\theta_1) - \sin^2(\theta_0)}$$

$$a_\theta = \sqrt{\cos^2(0^\circ) - \sin^2(1.71^\circ)}$$

$$a_\theta = 0.9996$$

$$\beta \cong \tan^{-1} \left( \frac{\cos(0^\circ + 90^\circ)}{\frac{2 \cdot \sqrt{1 - 0.9996^2}}{0.547 \cdot \tan(42^\circ)} + \sin(0^\circ + 90^\circ)} \right)$$

$$\beta \cong 0$$

$$\eta_1 \cong \eta_0 \left[ \frac{1 + \sin(\lambda + \beta + \theta)}{2} \right]$$

$$\eta_1 \cong 0.547 \left[ \frac{1 + \sin(0^\circ + 0^\circ + 90^\circ)}{2} \right]$$

$$\eta_1 \cong 0.547$$

3. Assuming the angle of repose,  $\phi = 42^\circ$ , the safety factor for resisting motion is then.

$$SF = \frac{a_\theta \cdot \tan(\phi)}{\eta_1 \cdot \tan(\phi) + \sqrt{1 - a_\theta^2} \cdot \cos(\beta)}$$

$$SF = \frac{0.9996 \cdot \tan(42^\circ)}{0.547 \cdot \tan(42^\circ) + \sqrt{1 - 0.9996^2} \cdot \cos(0)}$$

**SF = 1.73**

A safety factor greater than one indicates that the rock is stable enough to resist motion. An iterative approach shows stable diameters down to 1.75 ft, but a safety factor below 1.2 is not recommended. Water will pool behind the boulders with lower velocities than normal depth on the ramp. At a low-flow design discharge of 45 ft<sup>3</sup>/s, assuming a roughness increase to 0.09, the normal depth on the ramp would equal 2.4 ft. Since the sides are only 2 feet tall, excess water would spill over the sides of the low flow channel in the ramp. Normal depth calculations estimate approximately 28 ft<sup>3</sup>/s of surface flow will remain in the channel resulting in less depth immediately downstream of the rocks. Normal depth calculations using 28 ft<sup>3</sup>/s, and the original 0.06 roughness, estimate approximately 1.75 ft of depth with a velocity of 3.7 ft/s. Behind the rocks at a 2ft depth, continuity indicates pool velocities near 2.8 ft/s. Figure 7-1 shows a schematic of the water surface profile and rough estimate hydraulics.

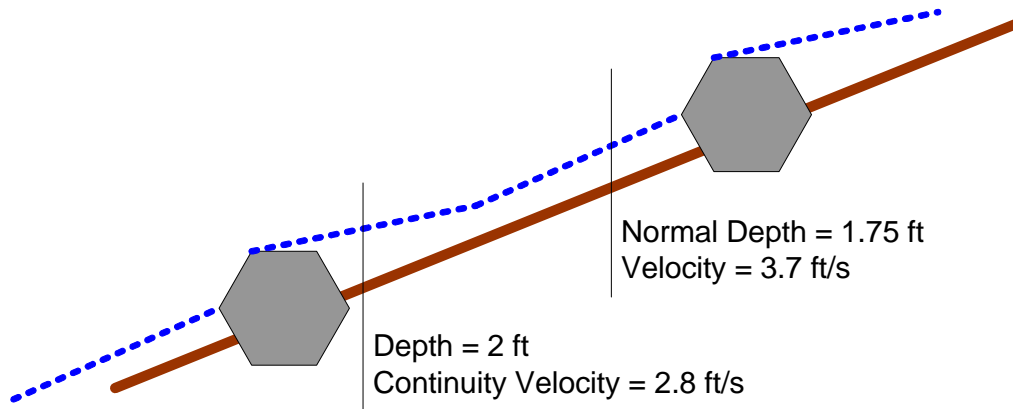

**Figure 7-1 Water Surface Profile Over Boulders**

Pier equations may overestimate scour because submerged boulders do not extend up the full height of the water column like piers. The value will represent a conservative estimate. The CSU equation computes pier scour as follows:

$$y_{s,p} = 2.0 \cdot K_1 \cdot K_2 \cdot K_3 \cdot K_4 \cdot a^{0.65} \cdot y_1^{0.35} \cdot Fr_1^{0.43}$$

$K_1 = 1.1$  for square nosed piers;

$K_2 = 1.0$  for a zero degree angle of attack;

$K_3 = 1.1$  for clear water scour; and

$K_4 = 0.2$  armor limiting condition, minimum values were ignored.

$$y_{s,p} = 2.0 \cdot (1.1) \cdot (1.0) \cdot (1.1) \cdot (0.2) \cdot (3\text{ft})^{0.65} \cdot (5\text{ft})^{0.35} \cdot (0.74)^{0.43}$$

**$y_{s,p} = 1.5\text{ft}$**

Construct the rocks below the depth of scour. The thickness of the riprap blanket should be increased locally to accommodate the scour hole or the scour hole carefully lined with immobile rock to prevent creating a weak point in the ramp.



The impact on high-flow hydraulics can be analyzed through changing the roughness. The crest continues to act as a critical depth control unless tailwater will submerge the ramp.

## 7.10 References

- Acharya, M., J.A. Kells, and C. Katopodis. (2000). Some Hydraulic Design Aspects of Nature-like Fishways,” Proceedings of the Joint Conference on Water Resources Engineering and Water resources Planning and Management, ASCE, Reston, VA.
- Bathurst, J.C. (1978). “Flow-resistance of Large-Scale Roughness,” Journal of the Hydraulics Division, ASCE Vol. 114, No HY12, p1587-1603.
- Barton, J.R. and Cron, F.W. (1979). Restoration of Fish Habitat in Relocated Streams, FHWA-IP-79-3.
- Boelman S. F. and O. R. Stein. (1997). Performance of In-Stream Boulder Clusters in a Cobble-Bed River, pp. 1049-1054 Proceedings, Environmental and Coastal Hydraulics: Protecting the Aquatic Habitat.
- Boelman, S. F., Stein, O. R., and Seal, R. ~1997!. “Hydraulic and geomorphic assessment of in-stream boulder clusters.” Proc., Conf. on Management of Landscapes Disturbed by Channel Incision, 684–688.
- Brunner, G.W. (2002). HEC-RAS Hydraulic Reference Manual. U.S. Army Corps of Engineers, Hydraulic Engineering Center, Davis, CA.
- Cullen, R.T. 1989. Fish Habitat Improvement from Scour and Deposition Around Fishrocks. Masters Thesis. Dept. of Civil and Environ. Engrg., Wash. State University. Pullman, Wash.
- Cullen, R.T. (1991). “Vortex mechanisms of local scour at model fishrocks”. American Fisheries Society Symposium 10:213-218.
- Fisher, A.C. and P.C. Klingeman. 1984. Local Scour at Fishrocks. *In*: Schreiber, D.J., ed. Water for Resource Development. Conf. Proc. Hydraulics Div., Amer. Soc. Civil Engrs.
- Fischenich, C., and Seal, R. (1999). "Boulder clusters," EMRRP Technical Notes Collection (ERDC TN-EMRRP-SR-11), U.S. Army Engineer Research and Development Center, Vicksburg, MS. [www.wes.army.mil/el/emrrp](http://www.wes.army.mil/el/emrrp).
- FISRWG (10/1998). Stream Corridor Restoration: Principles, Processes, and Practices. By the Federal Interagency Stream Restoration Working Group (FISRWG)(15 Federal agencies of the US gov't). GPO Item No. 0120-A; SuDocs No. A 57.6/2:EN3/PT.653. ISBN-0-934213-59-3.
- FRISSELL, CHRISTOPHER A. AND RICHARD K. NAWA Incidence and Causes of Physical Failure of Artificial Habitat Structures in Streams of Western Oregon and Washington Oak Creek Laboratory of Biology Department of Fisheries and Wildlife, Nash Hall 104 Oregon State University, Corvallis, Oregon 97331, USA North American Journal of Fisheries Management 12: 182-197, 1992 © Copyright by the American Fisheries Society 1992

- Lacer, R.W.J., and Roy, A.G. (2004). Hydrodynamic characteristics of boulder and pebble clusters in a natural environment. 100<sup>th</sup> Annual Meeting of the Association of American Geographers. 14-19 March 2004., Philadelphia, Pennsylvania.
- Lere, M.E. (1982). The long term effectiveness of three types of stream improvement structures installed in Montana Streams. Master's Thesis, Montana State University, Bozeman, MT.
- Mefford, B. (2005) Lecture Notes. Bureau of Reclamation, Technical Service Center, Denver, CO.
- Moreau, J.K. 1984. Anadromous Salmonid Habitat Enhancement by Boulder Placement in Hurdygurdy Creek, California. *In*: Hassler, T.J., ed. Proceedings of Pacific Northwest Stream Habitat Management Workshop. Humbolt State Univ., Arcata, Calif.
- Orsborn, J.F. and T.W. Bumstead. 1986. Habitat Improvement Plan for Portions of Chesnimnus Creek. Report prepared for Oregon Dept. Fish and Wildlife.
- Province of Alberta (2001). Fish Habitat Manual, Fact Sheet C14. <http://www.trans.gov.ab.ca/Content/doctype123/production/fishhabitatmanual.htm>
- Richardson and Davis (1995) HEC 18.
- Seehorn, M.E. 1985. Fish Habitat Improvement Handbook. U.S. Forest Service, Southern Region Tech. Pub. R8-TP7.
- Stein, O.R. and Boelman, S.F. (1996) Waterways Experiment Station, U.S. Army Corps of Engineers Contract # DAWC39-96-K-0025.
- Swales, S. (1989) "The Use of Instream Habitat Improvement Methodology in Mitigating the Adverse Effects of River Regulations on Fisheries," in Alternative in Regulated River Management, James A Gore, editor, CRC Press, Inc., Boca Raton, FL pp185-208.
- Zgheib, P.W. (1992). Profile and energy of transitional tumbling flow around a large bed element. *Journal of Hydraulic Research*. 31:4. 479-494.
- Taccogna, G. and K. Munro (eds). 1995. The Streamkeepers Handbook: a Practical Guide to Stream and Wetland Care. Salmonid Enhancement Program, Dept. Fisheries and Oceans, Vancouver, BC.
- Ward, B. R. 1997. Using boulder clusters to rehabilitate juvenile salmonid habitat. *In* Slaney P.A. and D. Zaldokas (editors) Fish habitat rehabilitation procedures. Watershed Restoration Technical Circular No. 9. Watershed Restoration Program. Ministry of Environment, Lands, and Parks, Vancouver, B.C.

## 8.0 Constructed Step-Pools

### 8.1 Overview

Step-pool structures are characteristic of relatively steep, coarse-grained mountain streams; and provide both grade control during high flows and instream habitat during low flows. They are typically made of large rock in alternating short steep drops and longer low grade sections (Figure 8.1). The number of steps is determined by the extent of the drop in invert of the stream. There are various configurations and arrangements of rock that can be utilized provided the rock is large enough to be essentially immobile and the drops are low enough to allow aquatic life to migrate upstream.

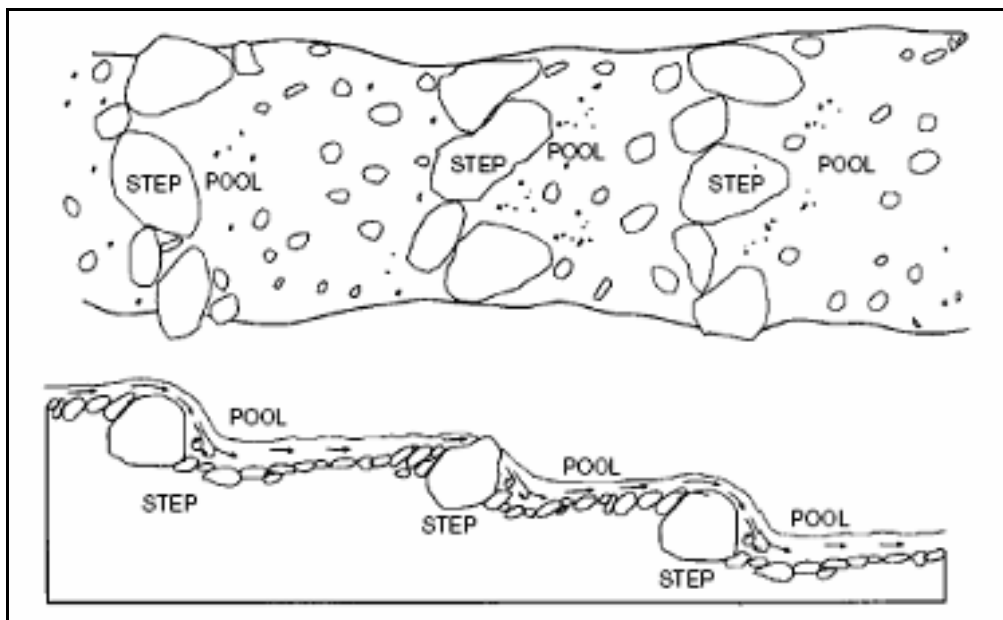

Figure 8.1 – Step-pool characteristics (from Lenzi, 2001)

Step-pool structures are being widely used to provide vertical stability in channel restoration projects and habitat enhancement in severely disturbed streams. However, the use of such structures in geomorphic settings that have very different characteristics than those where they are found naturally results in a high degree of failure exceeding 50 percent over 10 to 20 years (Morris, 1995). Reasons for these failures are numerous, but Thomas et al (2000) state that the principal reasons include the absence of design criteria for locating and sizing the structures. For example, the construction of a step-pool structure on a migrating stream may be out flanked as the river channel migrates across the floodplain. This chapter summarizes the current state of best practices found in the literature for integrating step-pool structures as functioning, low-drop grade-control

structures, and habitat enhancement features. Table 8-1 lists advantages and disadvantages to installing step-pool structures in a stream.

**Table 8-1 Step-pool structure advantages and disadvantages**

<b>Advantages</b>	<b>Disadvantages</b>
Low material cost	Labor intensive construction
Low maintenance	Potential bank destabilization
Source of cover	Potential bed destabilization
Source of resting areas	Potential boating safety hazard
Great structural variety, Deformable	Inappropriate in sandy and other fine-grained streams
Natural aesthetics	Greater uncertainty of long-term durability

After comparing the advantages and disadvantages of step-pools compared to other alternatives and determining the desirability, the site specific conditions should be compared to the range of applicability.

## 8.2 Range of applicability

Siting step-pool structures is a critical component of the design process. WDFW (2004) notes that rock weir drop structures should be located in straight channel sections and not installed in bends or meandering channels. They are inappropriate in aggrading reaches and caution should be exercised when installing drop structures in laterally dynamic channels with the potential for migration or avulsion that could bypass the structure. Channel or ramp slopes also must be considered in the design and application of step-pool structures. Applicable gradients for step-pool structures cover a large range of slopes. Table 8-2 summarizes the ranges recommended in the reviewed literature.

**Table 8-2 Applicable ranges of gradients for step-pools**

<b>Gradient</b>	<b>Reference</b>
S>2%	Chin 1989
S>3%	DVWK 2002
1%<S<7%	WDFD 2004
S>4%	Thomas et al 2000

The range of applicable gradients acts as a surrogate for step height, velocity, rock size, and structure spacing. Evaluating the specific project goals targeted by step-pools and a site specific evaluation by an expert such as a geomorphologist or hydraulic engineer on whether step-pools will meet design criteria is very crucial. Elements to consider include:

- Step height
- Step-pool frequency/length
- Velocity impacts on fish passage

- Required stable rock diameter
- Potential scour dimensions and pool geometry

Most often a geomorphic analysis of the reach is needed to determine if the reach is stable or unstable under current conditions and how that might change after installing step-pool structures. If a designer determines step-pools might fulfill a project objective, the analysis process will assist in narrowing the applicability requirements. The following design questionnaire presents some methods for determining the applicability of step-pools:

- Is the existing or planned velocity, depth, or amount of cover undesirable?
- Is the channel stable in profile?
- Are the banks stable?
- Is the required rock diameter available?
- Is the predicted scour pool acceptable?
- Are the predicted local depth and velocity conditions desirable?

### **8.3 Step-Pool Characteristics**

Step-pool structures are generally composed of a few very large boulders that play a key role in the stability and function of the step. Step-pool structures are commonly constructed in a broad U-shape, with the apex of the weir pointing upstream. The curvature of the weir tends to align the flow towards the center of the downstream pool. This has two important effects: (1) alignment of flow into the downstream pool helps maintain the downstream scour hole, and (2) it prevents flow from being directed towards the outer banks, and therefore, limits bank erosion (Thomas et al., 2000). Two morphological dimensions can easily be determined for step-pools. Step height as the vertical drop generated by a step and the step length or wavelength as the distance parallel to the slope separating steps.

#### **8.3.1 Step Height**

When constructing step-pool structures for fish passage, the step height and pool dimensions must be constructed such that local agency fish passage criteria are met. For channel stabilization purposes, the drop height will reflect the elevation loss that must be accommodated to stabilize the channel while meeting the low-drop criteria. The various methods for calculating step height found in the literature are presented in Table 8-3.

Table 8-3 Step height

Method	Reference
Relative drop height $H/y_c \leq 1$ Where: H=Weir Drop Height $y_c$ =critical depth	Thomas et al. 2000
Step Steepness $H/L=1.5*S$ (H/LS) values between 1 and 2 provide maximum flow resistance Where: H=Weir Drop Height L=Weir Spacing or Step Length S=Channel Slope	Abrahams et al. 1995
H=Depends on fish species	Local agency fish passage criteria

### 8.3.2 Step-Pool Frequency

Spacing between steps in the literature ranged from one to four channel widths and generally decreased with increasing channel slope which Whittaker and Jaeggi (1982) related to maximum flow resistance. The various methods for calculating step-pool spacing found in the literature are presented in Table 8-4.

Table 8-4 Step-pool frequency

Method	Reference
$L=0.31*S^{-1.19}$ Where: L=step-pool spacing (m) S=channel slope	Whittaker 1987
Step-Pool spacing = 2-3 channel widths	Knighon 1998
$L=f(H, ACW, S_o, q_{design})$ Where: H=Weir Drop Height ACW=Active Channel Width $S_o$ =Channel Slope $q_{design}$ =Design unit discharge	Thomas et al. 2000
Step-pool spacing = 0.43-2.4 channel widths	Chin 1989
Select L such that $\Delta h_{wse} \leq 0.2m$	DVWK 2002
$H/L=1.5*S$	Abrahams et al. 1995
$P_s = 8.2513 S_o^{-0.9799}$ Where: P <sub>s</sub> = pool spacing/bankfull width	Rosgen 2001

### 8.3.3 Step Rock Size

The size of boulders used must be large enough to simultaneously resist movement as well as create the desired hydraulic conditions. Definitive design criteria for sizing the boulders comprising the step structures is very limited, indicating that the size of the boulders is determined more by the available rock dimensions than by channel hydraulics. A study of eight, steep, coarse grained mountain streams in Colorado by Thomas et al. (2000) found that the average A-axis dimension (long axis) of boulders was 2 ft, and the average B-axis dimension (intermediate axis) was 1.7 ft. Applicable rock sizes cover a large range of values.

To determine the size of boulders for construction of man-made step-pool structures, Thomas et al. suggest using the U.S. Army Corps of Engineers “steep slope riprap design” method (COE, 1991), but note that these should be supplemented with anchor boulders (footers) that should be placed along the base of the step-pool structure to provide additional support and stability.

$$D_{30} = \frac{1.95 \cdot S^{0.555} \cdot q^{2/3}}{g^{1/3}} \quad \text{Equation 8-1}$$

Where,

S = slope of the rock ramp;

q = design unit discharge, USACE (1991) recommends a 1.25 flow concentration factor such that  $q=1.25(Q/W)$ ;

g = acceleration due to gravity; and

$D_{30}$  = characteristic stone size 30 percent quantile.

The COE relationship for steep slope results in a  $D_{30}$  that must be translated to a  $D_{50}$  for comparison with other methods.

$$D_{50} = D_{30} \cdot \left( \frac{D_{85}}{D_{16}} \right)^{1/3} \quad \text{Equation 8-2}$$

The minimum rock size may have to be increased to allow for burial, which will reduce the potential for local scour on the downstream side of the weir.

## 8.4 Hydraulics

Hydraulically, step-pool structures behave similar to broad crested weirs but the local flow characteristics resulting from the arched crest of the structure require methods outside of 1D hydraulic modeling. As a result, physical or multi-dimensional numerical modeling is needed to determine specific velocity conditions created by step-pool structures. One dimension analysis would only be adequate when the design can accept a high level of uncertainty. The downstream tailwater control regulates the water-surface elevation of the pool, which in turn

affects the energy dissipation and available habitat. The spacing of structures and/or the degree of downstream channel contraction is important in terms of function of the step-pool structure. Small amounts of contraction and large structure spacing provides little control of the pool tailwater and creates high velocities throughout the downstream pool. Too much contraction and/or a structure spacing that is too short results in an elevated tailwater that may lead to sediment deposition within the pool and submergence of the weir. Thomas et al. (2000) indicated that the width of the downstream control should be approximately 90 percent of the weir width under low-flow conditions and the maximum pool width should be approximately 20 percent larger than the weir width under low-flow conditions (Figure 8.2).

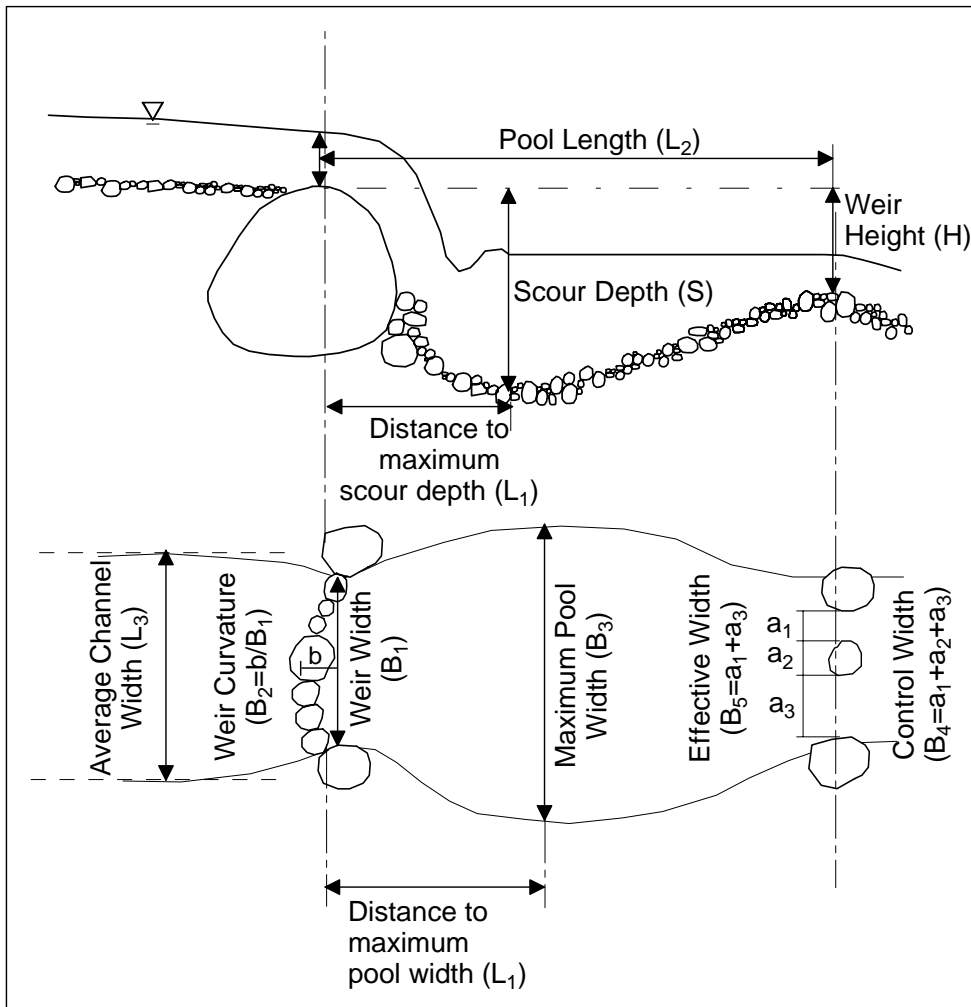

Figure 8.2– Step-pool characteristics (from Thomas et al. 2000)

## 8.5 Estimating Scour Hole Depth

Scour downstream of steps increases the depth locally and creates hydraulic diversity. The formation of a scour pool can also undermine the rocks comprising the structure. Continued scour pool formation and rolling of the rocks into the



scour hole can lead to failure of the structure. To prevent partial or full loss of the structure, the structure foundation should be embedded to a depth greater than the anticipated scour.

### 8.5.1 Recommended Values

Literature on constructed step-pool design lacks quantitative information on predicting scour. While specific scour predictions for constructed step-pools are not evident, predictions for scour depth immediately downstream of vertical drop structures should provide some guidance.

Simons and Sentürk (1992) provide several relationships for calculating scour downstream of hydraulic structures with the caveat that all structures are unique and therefore exhibit some variance in scour dimensions for similar structure configurations. For plunging flow over a sill, Schoklitsch (1932) has the following relationship for the depth of scour:

$$d_s = 4.75 \cdot \frac{H^{0.2} \cdot q^{0.5}}{D_{90}^{0.32}} \quad \text{Equation 8-3}$$

Where,

$d_s$  = total depth from the downstream water surface to the deepest point in the scour hole, meters;

$H$  = difference between the upstream energy grade line and the downstream water surface, meters;

$q$  = water discharge per unit width, meters squared per second; and

$D_{90}$  = particle diameter for which 90 percent of the material is finer, millimeters.

Eggenberger (1943) and Jäger (1939) developed formulas for flow split between a submerged jet and spill over. An empirical coefficient,  $C$ , defines the scour for a particular split condition. For all flow spilling over,  $C = 22.88$ . Equation 8-4 shows the Eggenberger formula and equation 8-5 shows the Jäger formula.

$$h_s = d_s + h_d = C \cdot \frac{H^{0.5} q^{0.6}}{D_{90}^{0.4}} \quad \text{Equation 8-4}$$

$$h_s = d_s + h_d = 6 \cdot H^{0.25} \cdot q^{0.5} \cdot \left( \frac{h_d}{D_{90}} \right)^{1/3} \quad \text{Equation 8-5}$$

Where,

$h_s$  = total depth from the downstream water surface to the deepest point in the scour hole, meters;

$d_s$  = total depth from the downstream bed to the deepest point in the scour hole, meters;

$h_d$  = water depth in the downstream reach, meters;

C = coefficient based on a flow split, equal to 22.88 for spill over;

H = difference between the upstream energy grade line and the downstream water surface, meters;

q = water discharge per unit width, meters squared per second; and

D<sub>90</sub> = particle diameter for which 90 percent of the material is finer, millimeters.

Reclamation (1984) developed the following equation for predicting scour depth immediately downstream of a vertical drop structure and for determining a conservative estimate of scour depth for sloping sills:

$$d_s = KH^{0.225} \cdot q^{0.54} - d_m \quad \text{Equation 8-6}$$

Where,

d<sub>s</sub> = local scour depth (below unscoured bed level) immediately downstream of vertical drop (m);

q = discharge per unit width (m<sup>3</sup>/s/m);

H = total drop in head, measured from the upstream to downstream energy grade line (m);

d<sub>m</sub> = tailwater depth immediately downstream of scour hole (m); and

K = 1.9.

A large-scale model research carried out by Bormann and Julien (1991) enabled the calibration of an equilibrium equation based on particle stability and its validation in a wide range of conditions: vertical jets, wall jets, free overfall jets, submerged jets and flow over large-scale grade-control structures. According to the results of Bormann and Julien (1991; p. 590), the relationship for estimating *s* has the following form:

$$s = \left[ \frac{0.611}{[\sin(0.436 + \beta')]^{0.8}} q^{0.6} \frac{U_o}{g^{0.8} d_{90}^{0.4}} \sin \beta' \right] - z \quad \text{Equation 8-7}$$

Where,

g = acceleration due to gravity (m/s<sup>2</sup>);

z = difference in height between the crest of the grade-control structure and the bottom of the downstream undisturbed bed level (m);

U<sub>o</sub> = mean flow velocity at the weir crest (equal to the jet entering velocity) (m/s); and

β' = maximum side angle of scour hole (upstream face) (rad).

The angle β' (Figure 8.3) is approximately equal to the jet angle and has been experimentally inferred by Bormann and Julien (1991):

$$\beta' = 0.316 \sin \lambda + 0.15 \ln \left( \frac{z + y_o}{y_o} \right) + 0.13 \ln \left( \frac{h}{y_o} \right) - 0.05 \ln \left( \frac{U_o}{\sqrt{g y_o}} \right) \quad \text{Equation 8-8}$$

in which  $\lambda$  = downstream face angle of the grade-control structure (rad); and  $y_o$  = water depth at the crest (m).

D'agostino and Ferro (2004) developed the following equation for predicting scour on an alluvial bed downstream of grade-control structures:

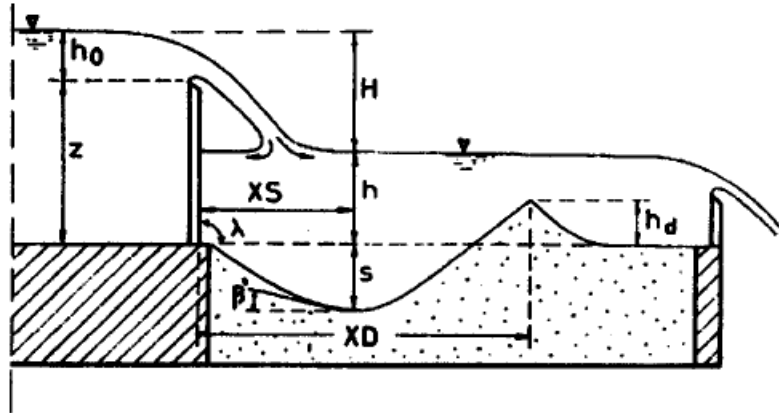

Figure 8.3 – Step-pool scour characteristics (from D'agostino and Ferro, 2004)

$$\frac{s}{z} = 0.975 \left( \frac{h_o}{z} \right)^{0.863} \quad \text{Equation 8-9}$$

Where,

$z$  = difference in height between the crest of the grade-control structure and the bottom of the downstream undisturbed bed level (m); and

$h_o$  = water depth at the crest (m).

## 8.6 Step –Pool Design

Incorporating step-pool design requires developing the structure plans as well as revising the initial rock ramp design. Step-pools include the following design steps:

6. Determining the applicability
7. Determining step height and step-pool frequency
8. Sizing the rocks
9. Computing scour hole dimensions
10. Revising the rock ramp design

The feasibility and overall objectives of the rock ramp should be re-evaluated after incorporating step-pools to determine if it is still the most effective and desirable means of meeting project goals.

## 8.7 References

- Abrahams, A.D., Li, G. and Atkinson, J.F. (1995) Step-pool streams: adjustment to maximum flow resistance. *Water Resources Research*. 31 p2593-602.
- Bormann, N. E., and Julien, P. Y., 1991. Scour downstream of gradecontrol structures. *Journal of Hydraulic Engineering*, v.117 (5), p. 579–594.
- Chin, A., 1989. Step pools in stream channels. *Progress in Physical Geography*. v. 13, p. 391-407.
- D'Agostino, V., and Ferro, V., 2004. Scour on Alluvial Bed Downstream of Grade-Control Structures. *Journal of Hydraulic Engineering*, v. 130 (1), p. 24-37.
- Grant, G.E. and Mizuyama, T., 1992. Origin of step-pool sequences in high gradient streams: a flume experiment. *Proceedings of Japan-U.S. Workshop on Snow Avalanche, Landslide, Debris Flow Prediction and Control*, p. 523-532.
- Grant, G.E., Swanson, F.J., and Wolman, M.G., 1990. Pattern and origin of stepped-bed morphology in high gradient streams, Western Cascades, Oregon. *Geological Society of America Bulletin*, v. 102, p. 340-352.
- Lenzi, M.A., 2001. Step-Pool Evolution in the Rio Cordon, Northeastern Italy. *Earth Surface Processes and Landforms*. 26:991-1008
- Morris, S.E., 1995. Geomorphic aspects of stream-channel restoration. *Physical Geography*, v. 16, no. 5, p. 444-459.
- Schoklitsch, A., 1932. “*Kolkbindung unter Ueberfallstrahlen*” *Die Wasserwirtschaft*, No. 24.
- Simons, D.B., Sentürk, F. 1992. *Sediment Transport Technology Water and Sediment Dynamics*. Water Resources Publication, Littleton, Colorado.
- Thomas, D.B., Abt, S.R., Mussetter, R.A., and Harvey, M.D., 2000. A Design for Sizing Step-Pool Structures.
- WDFW, 2004 Stream Habitat Restoration Guidelines: Final Draft
- Whittaker, J.G. and Jaeggi, M.N.R., 1982. Origin of step-pool systems in mountain streams. *Journal of the Hydraulics Division, Proceedings of the American Society of Civil Engineers*, v. 108, p.758-773.
- Whittaker, J.G., 1987a. Sediment transport in step-pool streams. *Sediment Transport in Gravel-bed Rivers*. C.R. Thorne, J.C. Bathurst, and R.D. Hey (eds.), John Wiley and Sons, Chichester, p. 545-579.

## 9.0 Conclusions and Future Work

### 9.1 Conclusions

The rock ramp guidelines reviewed existing literature and developed procedures and tools for analyzing and designing rock ramps to meet hydraulic performance and sustainability objectives. The state of the science has not advanced to the point of providing one procedure that functions across all ranges of site conditions and objectives. Designers must still exercise sound engineering judgment. The methods provide a way to understand and quantify decisions. Design elements include:

- Evaluating geomorphology, site specific conditions and the context of a structure within the larger watershed;
- Enumerating the required hydraulics to meet biological or regulatory requirements as well as other objectives;
- Determining the ramp geometry meeting the hydraulic requirements both at low and high discharges;
- Determining the economic tradeoffs of sizing material to remain stable up to a range of discharge events;
- Sizing the ramp material to remain stable up to a pre-determined discharge event; and
- Incorporating additional biologically significant features such as boulder design. Areas of high uncertainty clusters or step pools.

In many cases, the final design parameters will incorporate constraints determined through processes outside the realm of engineering computations. Social and political performance input may require solutions sub-optimal from a computational perspective. However, the cost of the value judgment can be quantified.

### 9.2 Future Work

The design process includes many calculations, some of which require iterative solutions. Coding the methods into a design tool may save designers time and money. Simulating multiple options and graphically displaying results reduces the time required to understand the processes and may allow solutions closer to optimum economically and performance. Improvements that can be made to the existing methods include:

- Fish usage of habitat features and ramp hydraulics
- Interstitial flow and riprap gradation
- Riprap stability for gradations approaching river bed material
- Cutoff walls

## Rock Ramp Design Guidelines

An investment in understanding these processes may lead to future cost savings through relaxing design criteria or increasing functionality.

# 10.0 Rock Ramp Design Example

## 10.1 Overview

The following paragraphs describe a hypothetical example of a rock ramp design. Example information is taken from the Chewuch River and the Fulton Diversion structure but altered from the actual design to prevent a direct comparison. Inputs were developed using the simplest techniques required to generate usable values. Actual inputs should be developed by knowledgeable engineers and evaluated in the context of ramp design.

## 10.2 Low Flow Design Discharge

Hydrologic analysis should be performed by engineers who understand the strengths and limitations of different analysis techniques. Figure 10-1 shows a flow duration curve for the mean daily discharge for the Chewuch River at Winthrop, WA for the available period spanning 1991 to 2004. The curve was constructed by ranking all reported discharges and matching flows with a frequency plotting position.

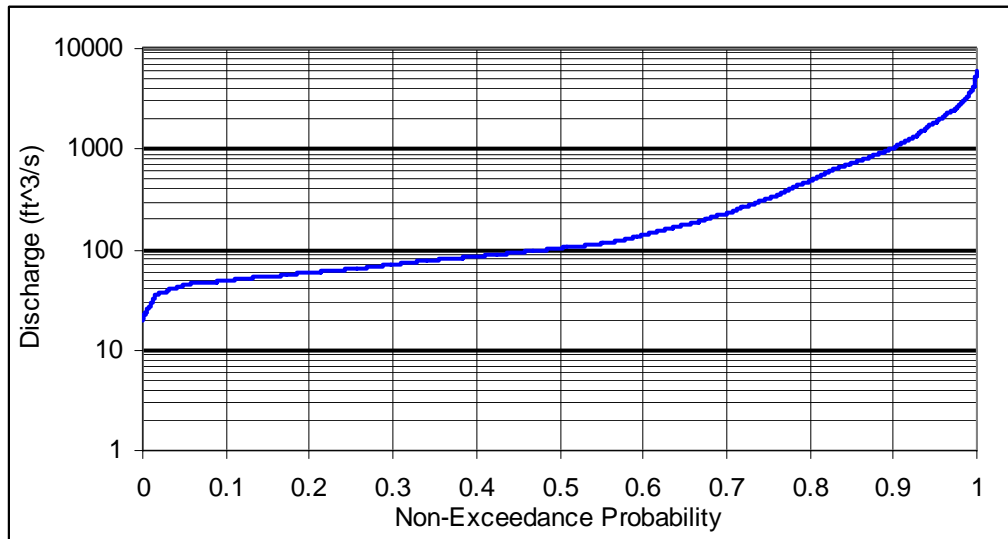

**Figure 10-1 Site Specific Example of a Mean Daily Flow Duration Curve**

For the site specific example, a 5-percent non-exceedance probability shows that the flow is less than or equal to 45 ft<sup>3</sup>/s for 5 percent of the year or approximately 18 days.

The flow duration curve does not specify when the 18 days might occur, but low flows tend to occur during late summer months. This specific curve represents one flow analysis technique for the purpose of constructing a

demonstration scenario and should not be used in an actual design. No evaluation was performed to determine whether the period of record includes a representative time period, contains only valid data, or is consistent with other gages in the basin. To use this hydrology technique, each ramp design will require constructing and evaluating a flow duration curve specific to each site.

### 10.3 Initial Riprap Diameter and Roughness Estimate

For this design example, the initial estimate of the required riprap size will assume a median diameter,  $D_{50}$ , of 2 feet. Manning’s roughness calculations using Rice et al. (1998) show an n-value of 0.046, Equation 10-1.

Given:

$$D_{50} = 2 \text{ ft}, 610 \text{ mm (Initial Guess); and}$$

$$S_0 = 0.04 \text{ (Initial Guess).}$$

Solve for Roughness, n:

$$n = 0.029 \cdot (D_{50} \cdot S_0)^{0.147} \quad \text{Equation 10-1}$$

$$n = 0.029 \cdot \left( 610 \text{ mm} \cdot 0.04 \frac{\text{ft}}{\text{ft}} \right)^{0.147}$$

$$\boxed{n = 0.046}$$

The initial riprap diameter and roughness value will be used to compute low flow hydraulics. The low flow hydraulics may identify an alternate slope and require an additional iteration. The n-value will then require updating based on the new slope.

### 10.4 Interstitial Flow Velocity

The Abt et. al (1987) relationship for interstitial flow provides an estimate for the velocity of water passing through the interstitial spaces of the ramp. Input values are site specific and depend on the character of the available material and ramp dimensions. Equation 10-2 shows the interstitial velocity computations.

Given:

$$n_p = 0.45 \text{ (measured value);}$$

$$S_0 = 0.04 \text{ (initial guess);}$$

$$g = 9.81 \text{ m/s}^2 \text{ (constant);}$$

$$D_s = 2 \text{ ft} = 0.61 \text{ m (constant); and}$$

$$K' = 4 \text{ (constant).}$$

Solve for Interstitial Velocity,  $v_i$ :



$$v_i = n_p \cdot \left( S_0 \cdot g \cdot \frac{D_{50}}{K'} \right)^{1/2} \quad \text{Equation 10-2}$$

$$v_i = 0.45 \cdot \left( 0.04 \frac{ft}{ft} \cdot 9.81 \frac{m}{s^2} \cdot \frac{0.61m}{4} \right)^{1/2}$$

$$v_i = 0.11m/s$$

$$v_i = 0.36ft/s$$

The velocity of interstitial flow will span the width and depth of the riprap layer. To determine the amount of surface flow, first assume a rectangular riprap cross section and estimate the flow volume.

Given:

$$v_i = 0.36 \text{ ft/s (Equation 10-2);}$$

$$D_{50} = 2 \text{ ft, 610 mm (Initial Guess in Section 10.3); and}$$

$$\text{Ramp Bottom Width, } w = 50 \text{ ft (Initial Guess),}$$

Solve for Interstitial Flow Quantity,  $Q_i$ .

1. Estimate the riprap layer thickness

$$T_{\text{initial}} = D_{100} \text{ (Section 4.5)}$$

$$D_{100} = 2 D_{50} \text{ (Section 4.6)}$$

$$T_{\text{initial}} = 2 \cdot D_{50} = 2 \cdot 2 \text{ ft}$$

$$T_{\text{initial}} = 4 \text{ ft}$$

2. Determine the flow per unit width (continuity for a unit width)

$$q_i = v_i \cdot T$$

$$q_i = 0.36 \frac{ft}{s} \cdot 4 \text{ ft}$$

$$q_i = 1.44 \frac{ft^2}{s}$$

3. Solve for the total flow (unit width multiplied by the total bottom width)

$$Q_i = q_i \cdot w$$

$$Q_i = 1.44 \frac{ft^2}{s} \cdot 50 \text{ ft}$$

$$Q_i = 72 \frac{ft^3}{s}$$

Interstitial flow will include 1.4 ft<sup>3</sup>/s for every foot of ramp width. A 50-ft bottom width is predicted to convey 72 ft<sup>3</sup>/s through the interstitial spaces. The flow duration curve, Figure 10-1, shows the initial ramp estimates will convey all water through the interstitial spaces 30% of the year (100 days). Restricting flow through the riprap layer increases the amount of surface water available.

All methods for constricting flow will not be explored. This example will assume an upstream cutoff wall and a 10-ft wide triangular notch extending the longitudinal length of the channel. Flow will be contained in the low-flow channel with longitudinal sheet piles. The selection of this technique should not be construed as a recommendation for this method.

A 10-ft triangular notch results in a riprap cross section width of approximately 18 feet, 10 feet for the notch and 4 feet on each side for the riprap sides. The resulting interstitial flow is then:

$$Q_i = q_i \cdot w$$

$$Q_i = 1.44 \frac{ft^2}{s} \cdot 18 ft$$



To determine the surface flow, subtract the interstitial from the gage record. Table 10-1 shows a range of probabilities for different surface flows for the assumed ramp construction.

**Table 10-1 Surface Flow and Non-Exceedance Probability**

Non-Exceedance Probability (percent)	Gage Flow, Q (ft <sup>3</sup> /s)	Ramp Surface Flow, Q-Qi (ft <sup>3</sup> /s)
1	29	3
5	44	18
10	50	24
20	59	33

Table 10-1 shows the range of flows and the likelihood of meeting passage criteria on any given day. Selecting different probability levels determines how much flow is available to work with when designing the low flow channel. Grouting the ramp would have made almost all the gage flow available as surface flow for fish passage. Assuming regulations or agreements require meeting passage criteria on average, 5% of the time, the low flow design must meet passage criteria with 18 ft<sup>3</sup>/s of flow.

The initial interstitial flow calculations neglected the conveyance area in the riprap on the banks of the ramp, because an unlined channel spanning ramp without a low flow notch is unlikely to meet passage criteria even without the added complexity of bank riprap conveyance. The final analysis should include the area on the banks.

## 10.5 Low Flow Channel Geometry

The low flow design assumes passage criteria must be met with 18 ft<sup>3</sup>/s of surface flow. A triangular channel will provide the most depth for a given flow rate. Normal depth computations use continuity, Equation 3-9, and Manning's relationship, Equation 3-10. For a triangular section, the equations for the geometric properties (area as a function of depth, Equation 3-12 and wetted

perimeter, as a function of depth, Equation 3-13) allow for an explicit solution for normal depth,  $y_n$ , Equation 10-3.

For a surface discharge of 18 ft<sup>3</sup>/s and the initial estimates of riprap diameter and ramp geometry, the hydraulics can be check for compliance with passage criteria.

Given:

Compliance requires passage on average 5 % of the time  
(assumed)

Surface flow,  $Q = 18 \text{ ft}^3/\text{s}$  (Table 10-1)

Roughness,  $n = 0.046$  (Section 10.3)

Longitudinal Slope,  $S_0 = 0.04$  (Initial Guess)

Top width,  $w = 10 \text{ ft}$  (Initial Guess)

Low notch side slope,  $z_1 = 4$  (H:V)

Solve for normal depth,  $y_n$ , using the explicit solution for continuity and Manning's equation for triangular channels.

$$y_n = \left( \left( \frac{Q \cdot n}{\phi \cdot S_0^{1/2}} \right) \cdot \left( \frac{(2 \cdot \sqrt{1+z^2})^{2/3}}{z^{5/3}} \right) \right)^{3/8} \quad \text{Equation 10-3}$$

$$y_n = \left( \left( \frac{18 \text{ ft}^3/\text{s} \cdot 0.046}{1.482 \cdot (0.04 \text{ ft}/\text{ft})^{1/2}} \right) \cdot \left( \frac{(2\sqrt{1+4^2})^{2/3}}{4^{5/3}} \right) \right)^{3/8}$$

$$y_n = ((2.7935) \cdot (0.405))^{3/8}$$

$$y_n = 1.05 \text{ ft}$$

Solve for velocity,  $v$ , using Manning's equation (Equation 3-10) and triangular geometry relationships (Equation 3-12 and Equation 3-13):

$$v = \frac{\phi}{n} \cdot R^{2/3} \cdot S_f^{1/2}$$

$$R = \frac{A}{P}$$

$$A = z_1 \cdot y_n^2 = 4 \cdot (1.047 \text{ ft})^2 = 4.39 \text{ ft}^2$$

$$P = 2 \cdot y \cdot \sqrt{1+z_s^2} = 2 \cdot 1.05 \text{ ft} \cdot \sqrt{1+4^2} = 8.64 \text{ ft}$$

$$R = \frac{4.39 \text{ ft}^2}{8.64 \text{ ft}} = 0.51 \text{ ft}$$

$$v = \frac{1.482}{0.046} \cdot (0.51 \text{ ft})^{2/3} \cdot (0.04 \text{ ft/ft})^{1/2}$$

$v = 4.10 \text{ ft/s}$

If the depth and velocity for the initial guesses do not meet passage criteria or the designer wishes to minimize the length of the ramp, then the ramp geometry must be modified.

Selecting side slope and profile slopes which meet fish passage criteria can be facilitated by a grid as described in Section 3.4. Figure 10-2 shows depth as a function of ramp profile slope and low flow notch side slope. Figure 10-3 shows velocities as a function of ramp profile slope and low flow notch side slope.

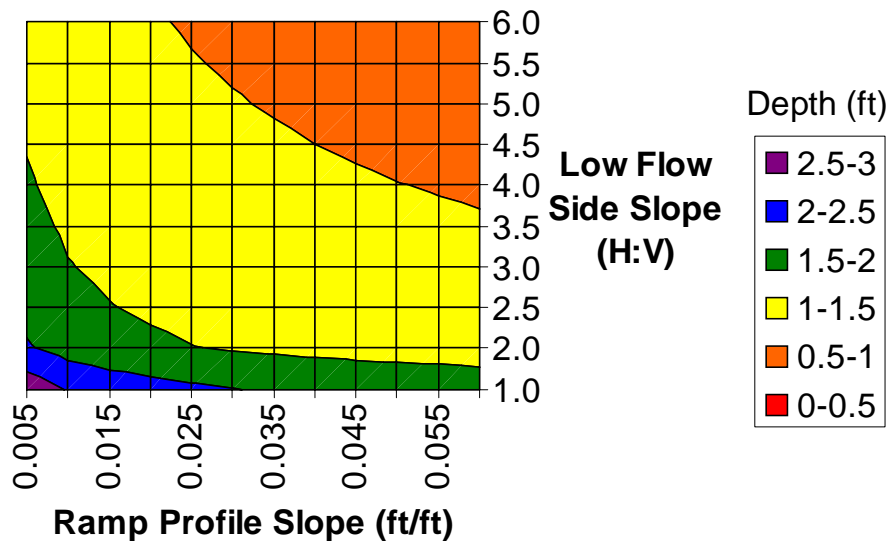

Figure 10-2 Depth as a function of low flow side slope and ramp profile slope for this example

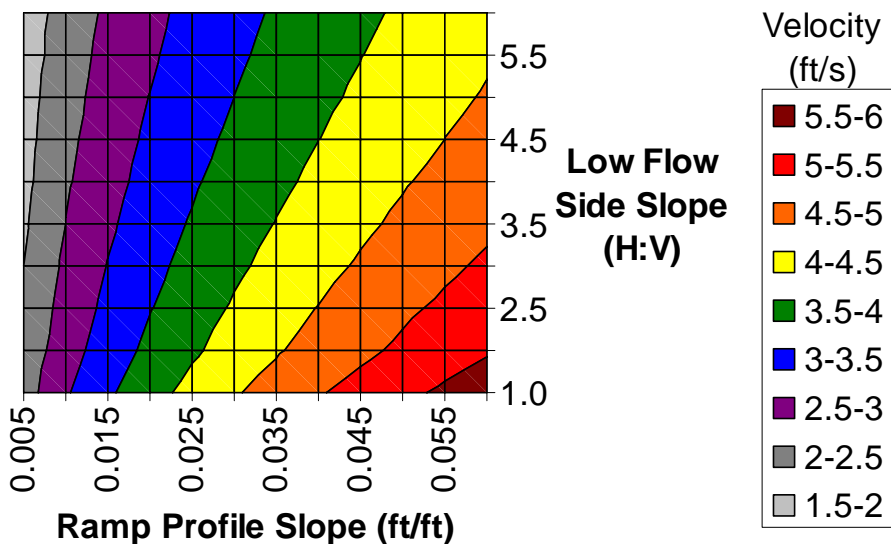
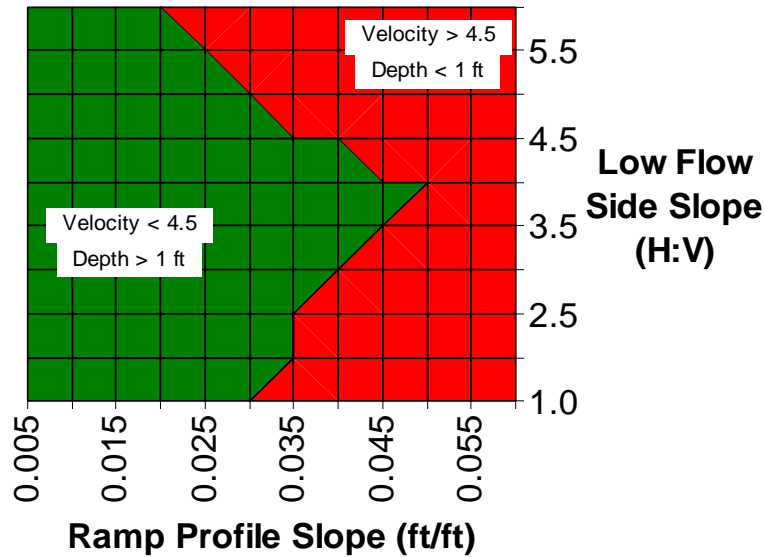

Figure 10-3 Velocity as a function of low flow side slope and ramp slope

By selecting a minimum depth of 1 foot and a maximum velocity of 4.5 ft/s (specified by fish species and target life cycle), Figure 10-4 shows the range of width and slope pairs meeting fish passage hydraulic criteria in green and unacceptable combinations in red.



**Figure 10-4 Low Flow Side Slope and Ramp Profile Slope combinations Meeting Hydraulic Criteria**

The final selection requires non-hydraulic criteria. In general, the shortest ramp will require the smallest amount of riprap material, but the largest riprap diameters. Designers can investigate a range of options by varying parameters and checking volumes and unit riprap costs. A design tool can generate a matrix of different options for comparison.

Figure 10-5 shows the initial estimate for cross section dimensions on the low flow channel.

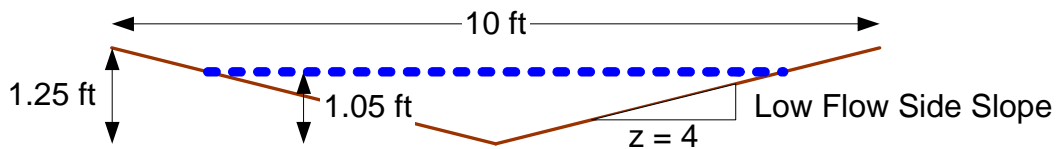

**Figure 10-5 Low Flow Channel Cross Section**

Within the low flow channel, the interstitial spaces between riprap particles will cause local increases and decreases in depth.

## 10.6 High Flow Design Discharges

To avoid increasing flood risk, a rock ramp should not increase flood stages. An analysis of existing or desired hydraulic conditions will identify a discharge to

be contained within the banks of the rock ramp. A high flow analysis should be performed by an experienced engineer. Figure 10-6 shows the recurrence interval for annual peak discharges.

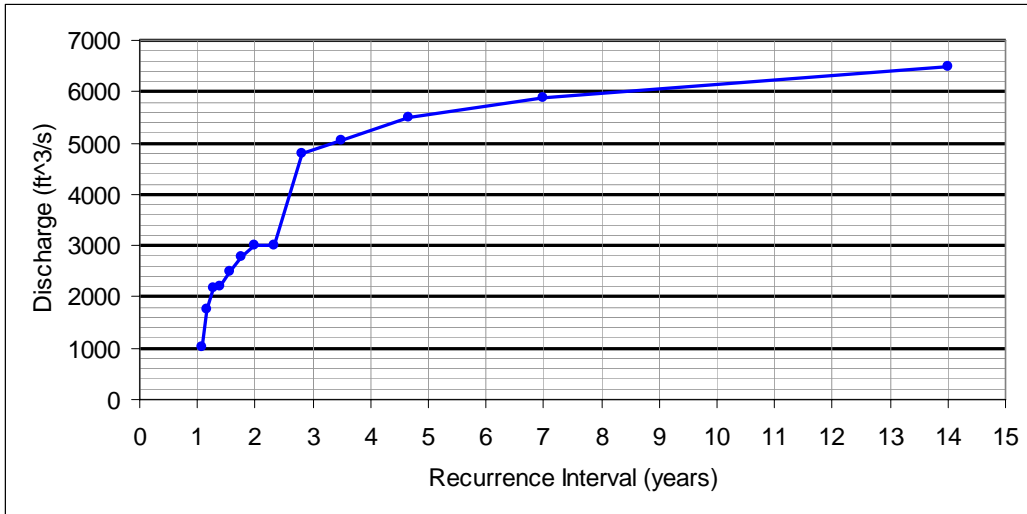

**Figure 10-6 USGS 12448000 Chewuch River at Winthrop, WA Annual Peak Recurrence Intervals**

On average, a discharge of 3,000 ft<sup>3</sup>/s would be expected to occur once every two years. A discharge of 6,200 ft<sup>3</sup>/s would occur on average once every 10 years. Recurrence intervals represent the probability that a certain flow event may occur in a given year. The 10-year recurrence interval has a 10% chance of occurring in any given year, but it may occur several times in one year or not at all for several years. This specific curve represents one flow analysis technique for the purpose of constructing a demonstration scenario and should not be used in an actual design. No evaluation was performed to determine whether the period of record includes a representative time period, contains only valid data, or is consistent with other gages in the basin.

## 10.7 High Flow Channel Geometry

High flow geometry should pass a high flow design discharge. Steeper banks and flatter lateral bed slopes contain larger amounts of flow. Construction requirements may limit the choice of ramp dimensions. Ramp computations assume the following channel dimensions from have been measured from the field and is independent of the other examples.

- Bank Height, 8 ft (measured from top of bank to toe);
- Bank Slope, 2:1, H:V (measured from top of bank to toe);
- Top Width, 120 ft (measured from top to top of bank);
- Bottom Width, 88 ft (measure from toe to toe);
- Roughness n-value of 0.045 (calibrated from a hydraulic model)

For the example, the following ramp design assumptions were made:

- 10-yr Design Discharge = 6,200 ft<sup>3</sup>/s (assumption)
- Lateral Slope of the high flow bed: 20:1 (H:V) Initial Guess.

Determining the high flow hydraulics requires determining whether the upstream flow is sub-critical or supercritical.

Given:

Main channel velocity,  $v = 9.45$  ft/s (hypothetical, would be computed from a hydraulic model);

Main channel hydraulic depth,  $D = 5.0$  ft (hypothetical, would be computed from a hydraulic model)

Solve from the Froude number, Fr

$$Fr = \frac{v}{\sqrt{g \cdot D}} \quad \text{Equation 10-4}$$

$$Fr = \frac{9.45 \text{ ft/s}}{\sqrt{32.2 \text{ ft/s} \cdot 5.0 \text{ ft}}}$$

**Fr = 0.74**

Flows upstream of the ramp are subcritical

The crest of the rock ramp acts as a step with a height,  $\Delta z$  equal to the difference between the bed of the natural channel and the crest of the ramp. Supercritical conditions cannot raise the upstream water surface elevation, but a large enough step can cause a hydraulic jump. For a subcritical cross section over the crest of the ramp versus a natural cross section, simultaneously solving specific energy (Equation 3-16), continuity (Equation 3-9), and Froude equal to 1 on the crest (Equation 3-17) results in the step height or bottom width without choking the flow.

Given:

Main channel velocity,  $v = 9.45$  ft/s (hypothetical, would be computed from a hydraulic model);

Main channel hydraulic depth,  $D = 5.0$  ft (hypothetical, would be computed from a hydraulic model)

Solve for the change in elevation,  $\Delta z$ , resulting in critical depth over the ramp crest.

Critical Depth and Continuity

$$\frac{Q}{A_{crest}} = \sqrt{g \cdot y_{crest}}$$

Specific Energy and Continuity

$$y_{channel} + \frac{v_{channel}^2}{2 \cdot g} = y_{crest} + \Delta z + \frac{\left(\frac{Q}{A_{crest}}\right)^2}{2 \cdot g}$$

Specific Energy, Continuity, and Critical Depth

$$y_{channel} + \frac{v_{channel}^2}{2 \cdot g} = y_{crest} + \Delta z + \frac{\left(\sqrt{g \cdot y_{crest}}\right)^2}{2 \cdot g}$$

To avoid choking the flow,  $y_{channel} = y_{crest} + \Delta z$

$$y_{crest} = y_{channel} - \Delta z$$

$$y_{channel} + \frac{v_{channel}^2}{2 \cdot g} = (y_{channel} - \Delta z) + \Delta z + \frac{\left(\sqrt{g \cdot (y_{channel} - \Delta z)}\right)^2}{2 \cdot g}$$

$$y_{channel} + \frac{v_{channel}^2}{2 \cdot g} = y_{channel} + \frac{g \cdot (y_{channel} - \Delta z)}{2 \cdot g}$$

$$\Delta z = y_{channel} - \frac{v_{channel}^2}{g}$$

$$\Delta z = 5.0 \text{ ft} - \frac{\left(9.45 \frac{\text{ft}}{\text{s}}\right)^2}{32.2 \frac{\text{ft}}{\text{s}^2}}$$

$$\Delta z = 2.23 \text{ ft}$$

For the 10-year flood, a ramp crest 2.23 ft above the bed of the ramp will not increase flood stages upstream of the ramp. The crest height does not consider the maximum amount of lateral constriction without impact to the water surface elevation upstream of the crest. If the step results in an inadequate elevation for diversions, the diversion will impact upstream water surface elevations.

Given:

Discharge,  $Q_{10} = 6,200 \text{ ft}^3/\text{s}$  (management decision);

Main channel hydraulic depth,  $D = 5.0 \text{ ft}$  (hypothetical, would be computed from a hydraulic model)

Main Channel Top Width,  $T_w = 120 \text{ ft}$  (hypothetical, would be computed from a hydraulic model)

Solve for the bottom width creating critical flow conditions,  $B_{w,critical}$   
Froude and Continuity at Critical Depth

$$\frac{Q}{A_{crest}} = \sqrt{g \cdot y_{crest}}$$

Assuming a trapezoidal geometry to compute area,  $A$

$$\frac{Q}{(B_w + z_{bank} \cdot y) \cdot y} = \sqrt{g \cdot y}$$

With a fixed top width, bottom width and the bank slope area related.



$$T_w = 2 \cdot z_{bank} \cdot y_{channel} + B_w$$

$$z_{bank} = \frac{T_w - B_w}{2 \cdot y_{channel}}$$

Substituting into continuity and solving for bottom width,

$$\frac{Q}{\left( B_w + \left( \frac{T_w - B_w}{2 \cdot y_{channel}} \right) \cdot y_{channel} \right) \cdot y_{channel}} = \sqrt{g \cdot y_{channel}}$$

$$B_{w,critical} = 2 \cdot \left( \frac{Q}{y_{channel}^{3/2} \cdot \sqrt{g}} - \frac{T_w}{2} \right)$$

$$B_{w,critical} = 2 \cdot \left( \frac{6,200 \text{ ft}^3/s}{(5.0 \text{ ft})^{3/2} \cdot \sqrt{32.2 \text{ ft/s}^2}} - \frac{120 \text{ ft}}{2} \right)$$

$$B_{w,critical} = 37.7 \text{ ft}$$

$$z_{bank} = \frac{120 \text{ ft} - 37.7 \text{ ft}}{2 \cdot 5 \text{ ft}}$$

$$z_{bank} = \frac{120 \text{ ft} - 37.7 \text{ ft}}{2 \cdot 5 \text{ ft}}$$

$$z_{bank} = 8.2$$

The maximum amount of contraction (assuming the crest elevation is even with the bed) is 38 feet resulting in a side slope for the high flow channel of 8.2 (H:V).

The actual construction of the ramp will likely include some elevation of the crest to create head for diversions as well as some contraction. The combination of a step and contraction can be checked for the impact on high flow water surface elevations using the same methods. The above assumptions simplify the channel and ramp as a trapezoid and use normal depth and specific energy to estimate hydraulics. The final design should check the values with a hydraulic model.

## 10.8 Riprap Design Flows

The riprap design discharge specifies what flow the ramp can withstand with little or no maintenance. The selection of a riprap design discharge may follow a procedure similar to the high flow geometry design discharge. Larger design discharges will withstand high events but require larger riprap diameters. Lower design discharges may save costs with smaller diameters but require more frequent replacement. A matrix of options can assist in making decisions. Balancing costs is described more thoroughly in Chapter 6 Design Event and Lifecycle Costs. The example will initially design the ramp to withstand a 10-

year event, 6,200 ft<sup>3</sup>/s. Data points were unavailable to extend the curve to higher recurrence events without a more involved hydrologic analysis.

Hydraulic analysis should be performed by an experienced modeler. The iterative phase can use normal depth assumptions, but the final design should be verified using a hydraulic model. Specifics on operating hydraulic models lie beyond the scope of this guideline. Table 10-2 reports the assumed hydraulics for the example rock ramp conveying 6,200 ft<sup>3</sup>/s.

**Table 10-2 High Flow Riprap Design Hydraulics**

Hydraulic Parameters	
Average Velocity (ft/s)	14.0
Average Depth (ft)	4.4
Bed Slope (ft/ft)	0.04
Bottom Width (ft)	80
Unit Discharge (ft <sup>2</sup> /s/ft)	77.5

The riprap diameter depends on the specific riprap formula, but the worst case hydraulic conditions generally occur at the highest velocity.

## 10.9 Bed Material Riprap Sizing

The range of techniques for determining the riprap size results in a wide variety of answers. Designers must evaluate which relationship best fits the project site. Selecting the final diameter requires understanding the background for the equations. Averaging applicable diameters smoothes potential differences in the relationships but does not address the processes.

Method	D <sub>50</sub> (in)
Abt and Johnson (1991)	25.5
Robinson et al. (1989)	13.1
Ferro (1999)	20.8
USACE (1991) Bed	40.1
Whittaker and Jäggi (1986)	20

Ferro combined data from Robinson and Abt. Whittaker and Jäggi (1986) tested more blocky type materials and therefore result in a smaller diameter. This example will assume the available riprap is more angular. Robinson et al. (1989) results in a value much lower than the other relationships. Robinson et al. does not include an envelope on the empirical fit and some of the tested points are 2 to 3 times larger than the regression relationship. A diameter between the USACE and Abt and Johnson (1991) methods would likely result in a stable ramp.

Lacking a specific site to validate based on field experience, the design example will specify a 30-in. median diameter,  $D_{50}$ , the average of Abt and Johnson and USACE.

### 10.9.1 Abt and Johnson (1991)

Abt and Johnson (1991) present Equation 10-5 for sizing riprap on embankments. A discussion of development is in Chapter 4.

$$D_{50} = \phi_e \cdot \phi_c \cdot a \cdot 5.23 \cdot S_0^{0.43} \cdot q_{sizing}^{0.56} \quad \text{Equation 10-5}$$

$\phi_e = 1.2$ , coefficient for the empirical envelope on the regression relationship;

$\phi_c = 1.2$  coefficient for flow concentration assuming sheet flow;

$a = 1$ , shape factor for rounded versus angular material;

$S_0 = 0.03$ , slope of the rock ramp; and

$q_{sizing} = 1.35 q_{design} = (1.35) * 77.5, \text{ft}^2/\text{s}/\text{ft} = 104.6 \text{ft}^2/\text{s}/\text{ft}$

$$D_{50} = 1.2 \cdot 1.2 \cdot 1 \cdot 5.23 \cdot \left(0.04 \frac{\text{ft}}{\text{ft}}\right)^{0.43} \cdot \left(104.6 \frac{\text{ft}^2}{\text{s}}\right)^{0.56}$$

$$D_{50} = 25.5 \text{in}$$

### 10.9.2 Robinson et al. (1998)

The sizing relationship for Robinson et al. (1989) for slopes less than 10% is shown in Equation 10-6.

$$q_{design} = 9.76 \cdot 10^{-7} \cdot D_{50}^{1.89} \cdot S_0^{-1.50} \quad \text{Equation 10-6}$$

$$D_{50} = \left( \frac{q_{design}}{9.76 \cdot 10^{-7} \cdot S_0^{-1.50}} \right)^{1/1.89}$$

$q_{design} = 77.5 \text{ft}^2/\text{s}/\text{ft}$ , unit discharge which needs to be in  $\text{m}^2/\text{s}$ ; and

$S_0 = 0.03$ , ramp slope; and

$$D_{50} = \left( \frac{77.5 \frac{\text{ft}^2}{\text{s}} \cdot 0.0929 \frac{\text{m}^2}{\text{ft}^2}}{9.76 \cdot 10^{-7} \cdot \left(0.04 \frac{\text{ft}}{\text{ft}}\right)^{-1.50}} \right)^{1/1.89}$$

$$D_{50} = 334 \text{mm} = 13.1 \text{in}$$

### 10.9.3 Ferro (1999)

Equation 10-7 shows the relationship from Ferro (1999)

$$\frac{D_{50}}{B} = \phi_e \frac{0.95}{(\sigma_g^2)^{0.562}} \cdot \left( \frac{Q \cdot S_0}{B^{5/2} \cdot g^{1/2}} \cdot \frac{\gamma_s - \gamma}{\gamma} \right)^{1/2} \quad \text{Equation 10-7}$$

$B = 80$  ft, channel width (rectangular cross section);

$\phi_e = 1.4$ , coefficient to include all of the empirical data in the regression relationship;

$\sigma_g^2 = 4$ , geometric variance of the gradation =  $D_{84}/D_{16}$ ;

$g = 32.2$  ft<sup>2</sup>/s, acceleration due to gravity;

$\gamma_s = 165$  lbs/ft<sup>3</sup>, specific weight of stone; and

$\gamma = 62.4$  lbs/ft<sup>3</sup>, specific weight of water.

$$D_{50} = B \cdot \phi_e \frac{0.95}{(\sigma_g^2)^{0.562}} \cdot \left( \frac{Q \cdot S_0}{B^{5/2} \cdot g^{1/2}} \cdot \frac{\gamma_s - \gamma}{\gamma} \right)^{1/2}$$

$$D_{50} = 80 \text{ ft} \cdot 1.4 \frac{0.95}{(4)^{0.562}} \cdot \left( \frac{6200 \text{ ft}^3/\text{s} \cdot 0.04 \text{ ft}/\text{ft}}{(80 \text{ ft})^{5/2} \cdot (32.2 \text{ ft}/\text{s}^2)^{1/2}} \cdot \frac{165 \text{ pcf} - 62.4 \text{ pcf}}{62.4 \text{ pcf}} \right)^{1/2}$$

$$D_{50} = 1.72 \text{ ft} = 20.8 \text{ in}$$

#### 10.9.4 USACE (1991) Bed

The Army Corps of Engineers relationship for steep slopes, Equation 10-8, results in a  $D_{30}$  that must be translated to a  $D_{50}$  for comparison with other methods, Equation 10-9.

$$D_{30} = \frac{1.95 \cdot S^{0.555} \cdot q^{2/3}}{g^{1/3}} \quad \text{Equation 10-8}$$

$S = 0.04$ , slope of the rock ramp;

$q = 77.5$  ft<sup>2</sup>/s, design unit discharge, USACE (1991) recommends a 1.25 flow concentration factor; and

$g = 32.2$  ft/s<sup>2</sup>, acceleration due to gravity.

$D_{30}$  = characteristic stone size 30 percent quantile;

$$D_{30} = \frac{1.95 \cdot 0.04^{0.555} \cdot (1.25 \cdot 77.5 \text{ ft}^2/\text{s})^{2/3}}{(32.2 \text{ ft}/\text{s}^2)^{1/3}}$$

$$D_{30} = 2.1 \text{ ft} = 25.2 \text{ in}$$

$$D_{50} = D_{30} \cdot \left( \frac{D_{85}}{D_{15}} \right)^{1/3} \quad \text{Equation 10-9}$$

$$D_{85}/D_{15}=4.$$

$$D_{50} = 25.2 \cdot (4)^{1/3}$$

$$D_{50} = 40.1 \text{ in}$$

### 10.9.5 Whittaker and Jäggi (1986)

Whittaker and Jäggi (1986) developed equation 10-10 for sizing blocks.

$$\frac{q}{\sqrt{g \cdot D_{65}^3 (G-1)}} \leq \frac{0.257}{S_0^{7/6}} \quad \text{Equation 10-10}$$

Where,

$q = 77.5 \text{ ft}^2/\text{s}$ , specific discharge;

$G = 2.65$ , specific gravity of the blocks;

$S_0 = 0.04$  ramp gradient; and

$g = 32.2 \text{ ft/s}^2$ , acceleration due to gravity.

$$\frac{q \cdot S_0^{7/6}}{0.257} \leq \sqrt{g \cdot D_{65}^3 (G-1)}$$

$$\left( \frac{q \cdot S_0^{7/6}}{0.257} \right)^2 \leq g \cdot D_{65}^3 (G-1)$$

$$\left( \left( \frac{q \cdot S_0^{7/6}}{0.257} \right)^2 \cdot \left( \frac{1}{g \cdot (G-1)} \right) \right)^{1/3} \leq D_{65}$$

$$\left( \left( \frac{77.5 \text{ ft}^2/\text{s} \cdot (0.04 \text{ ft}/\text{ft})^{7/6}}{0.257} \right)^2 \cdot \left( \frac{1}{32.2 \text{ ft}/\text{s}^2 \cdot (2.65-1)} \right) \right)^{1/3} \leq D_{65}$$

$$D_{65} \geq 1.82 \text{ ft} = 22.0 \text{ in}$$

$$D_{50} = 0.9 D_{65} = 0.9 \cdot 22.0 \text{ in}$$

$$D_{50} = 20.0 \text{ in}$$

Designers should select the relationship that best matches site conditions and appears reasonable. The average of the methods presented in the figure is 23.8 inches, but may not represent the best answer for a given site.

A poorer initial guess might require an iterative procedure with the second round resulting in a new roughness, new normal depth calculations, and new riprap size. The final solution requires an iterative procedure.

## 10.10 Bank Material Riprap Sizing

The Army Corps of Engineers Manual (EM1601 1991) describes a well validated and broadly applied method for sizing bank material Table 10-3 shows the input to the method.

**Table 10-3 Army Corps Riprap Inputs**

Input Parameter	Value
Specific Weight of Stone, pcf	165
Local Flow Depth, ft	4.4
Side Slope (H:V)	2.5
Bottom Width (ft)	80
Side Slope Concentration, $K_1$	0.95
Safety Factor	1.2

Side slope material is typically larger than bed material in order to counter increase pressures from gravity. The  $D_{50}$  of the side slope material should be at least 20 in.

**Table 10-4 Channel Pro Output for 165 pcf Stone**

$D_{100_{MAX}}$ (in)	$D_{100_{MIN}}$ (in)	$D_{50_{MAX}}$ (in)	$D_{50_{MIN}}$ (in)	$D_{15_{MAX}}$ (in)	$D_{15_{MIN}}$ (in)
33.0	24.3	22.0	19.3	17.5	13.1

A more conservative and typical safety factor of 2.0 results in a riprap diameter of 33 in., reasonably close the embankment results.