

GR-81-2

HYDRAULIC MODEL STUDIES OF McPHEE DAM SPILLWAY

*Hydraulics Branch
Division of Research
Engineering and Research Center
Bureau of Reclamation*

March 1981



1. REPORT NO. GR-81-2	2. GOVERNMENT ACCESSION NO.	3. RECIPIENT'S CATALOG NO.	
4. TITLE AND SUBTITLE Hydraulic Model Studies of McPhee Dam Spillway		5. REPORT DATE March 1981	6. PERFORMING ORGANIZATION CODE
7. AUTHOR(S) Clifford A. Pugh		8. PERFORMING ORGANIZATION REPORT NO. GR-81-2	
9. PERFORMING ORGANIZATION NAME AND ADDRESS Bureau of Reclamation Engineering and Research Center Denver, Colorado 80225		10. WORK UNIT NO.	11. CONTRACT OR GRANT NO.
12. SPONSORING AGENCY NAME AND ADDRESS Same		13. TYPE OF REPORT AND PERIOD COVERED	
15. SUPPLEMENTARY NOTES Microfiche and/or hard copy available at the Engineering and Research Center, Denver, Colo.		14. SPONSORING AGENCY CODE	
16. ABSTRACT A 1:36 scale model was used to develop the hydraulic design of the spillway for McPhee Dam located on the Dolores River in southwestern Colorado. The model included the approach channel, spillway crest and radial gates, spillway chute, combination stilling basin-flip bucket, and exit channel. The 18.3-m (60-ft) wide by 303-m (994-ft) long chute spillway is designed for a maximum discharge of 940 m³/s (33 130 ft³/s). Ordinarily, energy is dissipated in a hydraulic jump. For large floods, the flow will "sweepout" of the stilling basin into the exit channel. Model studies included investigation of approach flow conditions, pressures and flow distribution in the chute spillway, flow characteristics with the combination stilling basin-flip bucket, and flow conditions and erosion in the exit channel. Details of the testing and recommended design modifications are described.			
17. KEY WORDS AND DOCUMENT ANALYSIS a. DESCRIPTORS- / *model studies/ hydraulic models/ *spillways/ energy dissipation/ erosion control/ b. IDENTIFIERS- / *McPhee Dam, Colo./ Dolores Project/ c. COSATI Field/Group 13M COWRR: 1313.5			
18. DISTRIBUTION STATEMENT		19. SECURITY CLASS (THIS REPORT) UNCLASSIFIED	21. NO. OF PAGES 56
		20. SECURITY CLASS (THIS PAGE) UNCLASSIFIED	22. PRICE

GR-81-2

**HYDRAULIC MODEL STUDIES OF
McPHEE DAM SPILLWAY**

by
Clifford A. Pugh

Hydraulics Branch
Division of Research
Engineering and Research Center
Denver, Colorado
March 1981



UNITED STATES DEPARTMENT OF THE INTERIOR



BUREAU OF RECLAMATION

ACKNOWLEDGMENTS

This model study was conducted under the supervision of T. J. Rhone, Head of the Applied Hydraulics Section, and the general supervision of D. L. King, Chief of the Hydraulics Branch. The studies were accomplished through the cooperation of the Hydraulics Branch and Spillways and Outlets Section, Dams Branch, Division of Design of the Water and Power Resources Service, during the period from October 1978 through May 1979.

I also acknowledge Doug Stanton, Charles Cooper, and Marlene Young for their contributions to the hydraulic testing and data analysis, and T. J. Rhone for his technical review.

In May 1981, The Secretary of the Interior changed the Water and Power Resources Service back to its former name, the Bureau of Reclamation.

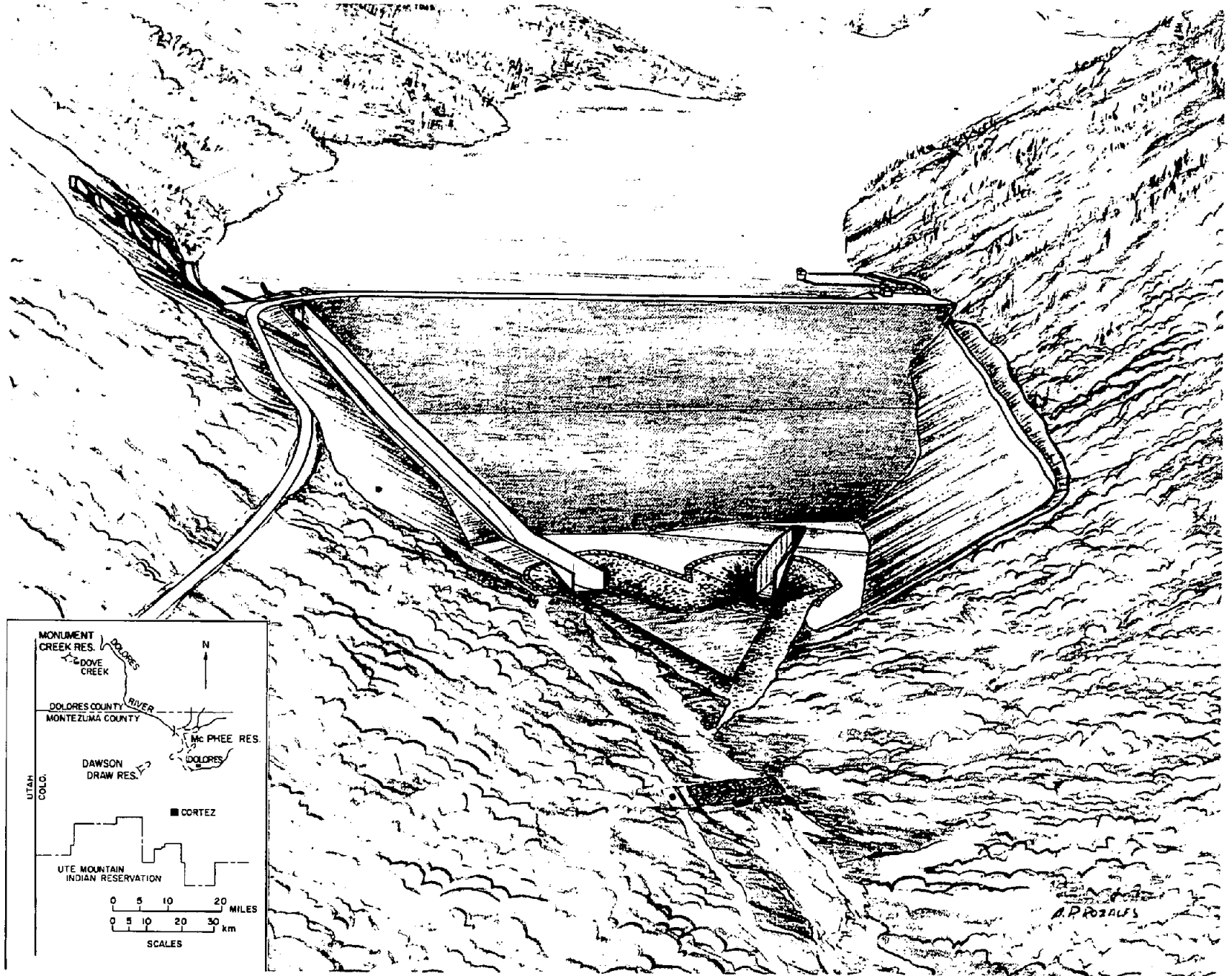

Location and artist's conception of McPhee Dam

CONTENTS

	Page
Purpose	1
Conclusions	1
Application	2
Introduction	2
The Model	3
Description	3
Scale relationships	4
Spillway chute roughness	5
Investigation	6
Spillway approach channel	6
Intake modification No. 1	6
Intake modification No. 2	7
Intake modification No. 3	7
Recommended design	8
One-gate operation	8
Spillway rating curves	8
Spillway chute	9
Subdrainage outlets	9
Chute drain outlets	10
Combination stilling basin-flip bucket	11
Original stilling basin and flip bucket	11
First flip bucket modification	12

CONTENTS—Continued

	Page
Second flip bucket modification	12
Third flip bucket modification	12
Exit channel excavation	13
Recommended exit channel design	14
Stilling basin debris tests	16
Test procedure	16
Results	16
Bibliography	19

FIGURES

Figure

Frontispiece	iii
1 Plan and profile of spillway	21
2 McPhee Dam spillway model in operation	23
3 Model spillway crest structure and radial gates	23
4 Preliminary design approach channel and exit channel	24
5 Approach channel modification No. 1	25
6 Approach channel modification No. 2	26
7 Discharge versus reservoir elevation for nongated flow	27
8 Approach channel modification No. 3	28
9 Recommended approach channel	29
10 Spillway rating curves—two gates	30
11 Spillway rating curves—left gate	31

CONTENTS—Continued

Figure	Page
12 Spillway rating curves—right gate	32
13 Chute blocks	33
14 Wall drains	34
15 Flow deflector and chute drain outlet	35
16 Stilling basin-flip bucket profiles	37
17 Original design stilling basin operation and erosion	39
18 Flip bucket modification No. 1 operating	40
19 Flip bucket modifications No. 2 and 3 operating	41
20 Flip bucket modification No. 3 with exit channel modification	42
21 Initial sweepout and sweepout reversal versus tailwater curve	43
22 Recommended exit channel	44
23 Recommended exit channel and stilling basin operating	45
24 Recommended stilling basin-flip bucket operating at sweepout flows	46
25 Plan of recommended exit channel	47
26 Stilling basin debris tests	48

TABLES

Table	
1 Combination stilling basins-flip bucket flow data	17
2 Stilling basin debris tests	18

PURPOSE

This hydraulic model study was conducted to evaluate the preliminary design of the spillway, investigate possible modifications to minimize downstream channel erosion, and optimize flow conditions in the approach channel.

CONCLUSIONS

1. The height of guide walls in the approach channel was raised above the maximum water surface, and the left wall alignment was changed to open the approach channel and guide the flow smoothly into the spillway chute.
2. Flow in the spillway chute is slightly nonuniform in the upstream portion of the chute due to asymmetric approach conditions. However, the distribution is very uniform where the flow enters the stilling basin.
3. The discharge capacity and pressures in the chute are satisfactory. The minimum freeboard in the chute is 3.28 m (10.75 ft) for the inflow design flood (IDF). Pressures on the chute floor are above atmospheric; however, the concrete finish should be smooth to avoid possible cavitation in the high velocity flow.
4. Pressure measurements were made on a chute block and the stilling basin wall to determine an acceptable location for subdrainage outlets. Chute blocks are not recommended because of the potential for cavitation damage. A wall drain location above the maximum "sweepout" water surface in the stilling basin was recommended. An "eyebrow"-type flow deflector was developed for floor drains in the spillway chute.
5. Four flip bucket configurations were tested. In the final design, the radius of the flip bucket was shorter and the lip elevation higher than in the original design. These changes helped stabilize the hydraulic jump and clear the jet impact away from the basin after sweepout with a minimum amount of damage to the downstream channel.

6. The discharge channel was deepened from elevation 2030.9 m (6663 ft) to elevation 2026.9 m (6650 ft). The channel was also widened so that it flared from 18.3 m (60 ft) wide at the stilling basin to 30.5 m (100 ft) wide downstream from the basin. These changes provide a wider and deeper channel and plunge pool to dissipate the energy of the jet striking the tailwater after sweepout. Removing the sand and gravel overburden in the jet impact area also reduces the possibility of a gravel bar forming downstream. Erosion will occur on the left bank of the outlet works channel after sweepout; however, this damage should not threaten the structures.

7. Flows large enough to cause sweepout will not be likely to occur. The initial sweepout flow is 465 m³/s (16 500 ft³/s), as compared to the 100-year flood of 375 m³/s (13 300 ft³/s). The outlet works can pass an additional 145 m³/s (5200 ft³/s). With the spillway and outlet works operating simultaneously, flows up to about 640 m³/s (22 700 ft³/s) could be passed before sweepout occurs.

8. The outlet works should be operated during the spillway sweepout to help supply tailwater in the plunge pool and to help prevent rocks from depositing in the outlet works channel and stilling basin.

9. A spillway flow of 200 m³/s (7000 ft³/s) is required to wash 75-mm (3-in) diameter rocks out of the stilling basin. At a flow of 255 m³/s (9000 ft³/s), rocks up to 1.5 m (5 ft) in diameter are washed out of the stilling basin.

APPLICATION

The results of this study can be applied to the design of radial gate controlled spillways discharging into a sloping chute and designs with combination stilling basin-flip bucket energy dissipators.

INTRODUCTION

An artist's conception of McPhee Reservoir is shown in the frontispiece of this report. McPhee Reservoir will be located on the Dolores River in southwestern Colorado.

McPhee will be the main storage and regulation reservoir in the Dolores Project. The project will provide irrigation water for the Montezuma Valley area and water supplies for the communities of Dove Creek, Towaoc, Cortez, and the Dolores Water Conservancy District.

The dam will be an earthfill structure 82.3 m (270 ft) high and 396.2 m (1300 ft) wide at the crest. The chute spillway and stilling basin will be located in the right abutment of the dam and will be 18.3 m (60 ft) wide and 303 m (994 ft) long. Figure 1 is a plan and profile of the recommended design for the approach channel, spillway, and exit channel.¹

THE MODEL

Description

The model was built to a geometric scale of 1:36 and included the approach channel and reservoir topography, the spillway crest structure and radial gates, the chute spillway, the combination stilling basin-flip bucket, and downstream river channel (fig. 2). Provisions were made for controlled releases into the river outlet works channel, as well as the spillway, in order to accurately simulate flow conditions in the downstream channel. However, the outlet works stilling basin was not modeled. Water was supplied to the model through the permanent laboratory system and discharges were measured with one of a bank of venturi meters in the laboratory supply system.

Topography in the approach channel and downstream river channel was molded of concrete. An area in the approach channel and exit channel was formed with gravel to study erosion characteristics and to facilitate changes in topography.

The spillway crest structure was constructed from high density polyurethane. The side walls and center pier were made from acrylic plastic. The radial gates were made of sheet metal with rubber strips fastened to the sides to provide a water seal (fig. 3).

¹ All figures follow the Bibliography.

The spillway chute and stilling basin were constructed from 20-mm (0.75-in) thick, resin-coated plywood. The flip bucket and vertical curves in the floor of the chute spillway were formed with sheet metal.

Rock baffles smoothed the flow coming into the approach channel from a 200-mm (8-in) supply line.

The reservoir elevation was measured with a hook gage in a well connected to a piezometer tap in the approach channel.

The tailwater elevation was controlled with a flap gate at the end of the model. Staff gages were located in the downstream river channel, the outlet works, and the stilling basin.

Scale Relationships

Inertia and gravity are the predominant forces acting on flow in open channels. The Froude number is the dimensionless ratio of inertia forces to gravity forces governing most open-channel flow situations. Dynamic similitude exists between the model and prototype when the Froude numbers are the same, equation 1:

$$\frac{V_m}{\sqrt{g_m L_m}} = \frac{V_p}{\sqrt{g_p L_p}} \quad (1)$$

where: V = velocity

g = gravitational acceleration

L = a characteristic length

Subscripts m and p refer to model and prototype. The geometric scale (or length ratio) is denoted by L_r , where $L_r = \frac{L_p}{L_m}$. The scale relations for this study (based on the Froude number) are:

	Quantity	Scale ratio
Length	$L_r =$	36:1
Area	$A_r = L_r^2 =$	1296:1
Time	$T_r = L_r^{0.5} =$	6:1
Velocity	$V_r = L_r/T_r = L_r^{0.5} =$	6:1
Discharge	$Q_r = V_r A_r = L_r^{2.5} =$	7776:1

The riprap in the exit channel area was geometrically scaled with gravel averaging 25 mm (1 in) in diameter to simulate 0.9-m (3-ft) riprap in the prototype.

Spillway Chute Roughness

In order for the model velocities entering the stilling basin to correctly simulate the prototype velocities, the model roughness must be scaled correctly. Using the Manning equation and the Froude law, it can be shown that Manning's n ratio, scales as the length ratio to the 1/6 (0.1667) power [1]², or:

$$n_r = \frac{n_p}{n_m} = L_r^{0.1667} = 1.817 \quad (2)$$

In a long chute spillway, an incorrectly scaled roughness can make a significant difference in the velocity at the end of the chute. It was projected that a smooth painted plywood surface would produce an n value of 0.009. This model n would represent a prototype n of 0.0165 (per equation 2). A backwater computer program [2] was used to determine velocities at the stilling basin for various roughness values in the prototype and in the model. According to Chow [3], the roughness coefficient (n) for concrete can be expected to range from 0.011 to 0.015 with 0.013 being a normal value. Therefore, an n_p value of 0.0165 would cause the velocity at the stilling basin to be too low. There are several possible methods to compensate for excessive roughness in the model. The

² Numbers in brackets identify Bibliography entries.

slope of the chute can be increased or the reservoir elevation can be increased to add extra velocity at the gates. In this study, the model chute was extended (at the same slope) an extra 0.91 m (3 ft) horizontally and 0.46 m (1.50 ft) vertically. According to the backwater program, this extra drop is equivalent to reducing n_p from 0.0165 to 0.015.

When the model was built, velocity and depth measurements indicated that the model was smoother than expected. The model n value was 0.007. With the extended chute, this simulates a prototype n of about 0.011. If the chute had not been extended, the simulated n_p would have been about 0.013. The prototype roughness simulated by the model ($n_p = 0.011$) is on the lower end of the possible prototype roughnesses. Therefore, the velocities at the stilling basin should be as high as would be expected in the prototype for a smooth concrete finish, and model simulations of stilling basin performance should be conservative.

INVESTIGATION

Spillway Approach Channel

In the original design approach channel (fig. 4a), the flow crossed the face of the dam from left to right and over the sloping left wall of the channel causing an asymmetrical approach condition. As a result, a large vortex formed in the right intake. Large contractions also formed along the walls during free flow.

Several approach channel modifications were tested and are described in the following paragraphs.

Intake modification No. 1. — The sloping walls in the preliminary design were increased in height to prevent flow from coming across the face of the dam (fig. 5a). The walls retained the same position and length but extended above the maximum water surface.

This arrangement eliminated the large vortex in the right intake; however, there were large contractions at the ends of the walls during free flow, and the velocity of approach was high in the intake channel.

Curved guide walls were added to the intake walls to eliminate the contractions (fig. 5b). These curved walls smoothed the flow coming into the approach channel. However, the velocity in the channel was still high, and the walls would be long and expensive to build.

Intake modification No. 2. — To eliminate the losses in the intake channel and minimize the wall length and construction costs, short curved walls leading directly into the intake were tested (fig. 6). The alinement of the left bank of the excavated channel and the side slopes were also changed to direct the flow into the intake.

This modified intake channel created much better approach flow. The current across the face of the dam and the large vortex in the right spillway bay were eliminated. With free flow, the pool elevation for the inflow design flood was reduced by 0.30 m (1.01 ft) from the preliminary design, EL 2111.55 to 2111.25 m (El. 6927.67 to 6926.66 ft). Figure 7 gives discharge versus reservoir elevation for nongated (free) flow conditions.

Although the short curved walls worked well hydraulically, problems with stability were anticipated in designing the intake channel and crest structure for this configuration.

Intake modification No. 3. — In this design, the left wall flared out starting 18 m (60 ft) upstream from the crest structure guiding the flow into the spillway. The top of the right wall sloped 2.5:1 (the same as in the preliminary design). This channel created a much better approach flow than the preliminary design. However, a contraction of the flow over the right wall (fig. 8a) caused eddies which moved material from behind the wall. This contraction also decreased the discharge capacity for free flow. The water surface elevation for the inflow design flood was 0.13 m (0.43 ft) higher than for the intake with the shorter curved walls (intake modification No. 2).

The top of the right wall was then raised to elevation 2111.65 m (6928.0 ft) and curved toward the 1:1 slope, 18 m (60 ft) upstream from the crest (fig. 8b). This configuration worked well hydraulically; however, difficulties in design again were anticipated with the curved wall.

Recommended design. — The right wall was then extended straight upstream at elevation 2111.65 m (6928.0 ft). The left wall remained the same. Figures 1 and 9 show the final design. This configuration directs the flow into the spillway with a minimum of contraction losses. The water surface elevation for the inflow design flood was 0.329 m (1.08 ft) less than with the original design (see fig. 7).

One-gate Operation

Slightly more flow passes through the right gate than the left for the same gate opening. Vortices start forming around the center pier at about 225 m³/s (800 ft³/s) for one-gate operation. The flow discharges freely over the crest for gate openings of more than 7.16 m (23.5 ft). The reservoir reaches maximum water surface elevation 2111.65 m (6928.0 ft) at a discharge of 480 m³/s (17 000 ft³/s). At this discharge, the minimum freeboard at the first vertical curve is about 1.2 m (4 ft). The flow distribution at the stilling basin is fairly uniform; therefore, one-gate operation could be used for prototype operation.

Spillway Rating Curves

The crest section was calibrated for uncontrolled flow and for one- and two-gate operation with the final design intake channel. The crest is capable of discharging the inflow design flood, 940 m³/s (33 130 ft³/s) at reservoir elevation 2111.22 m (6926.6 ft). This elevation is 0.43 m (1.4 ft) less than the maximum design reservoir elevation and will allow extra freeboard or extra discharge capacity.

Gate openings were measured vertically from the spillway crest elevation 2102.21 m (6897.0 ft). The flow can be controlled by the gates up to a discharge of 875 m³/s (31 000 ft³/s) at reservoir elevation 2111.65 m (6928.0 ft); this requires a 7.16-m (23.5-ft) gate opening. If the gates are

opened more than 7.16 m (23.5 ft), they no longer control and weir flow occurs. Rating curves for two-gate operation are given in figure 10. The data points shown are experimental points measured in the model. The curves were computed according to procedures in Design of Gravity Dams [4]. The coefficients were adjusted to match the experimental data. Figures 11 and 12 are rating curves for one-gate operation.

Spillway Chute

The spillway chute (fig. 1) is 18.3 m (60 ft) wide and drops 76.9 m (252.25 ft) in elevation from the end of the piers to the upstream end of the stilling basin, 227.8 m (747.5 ft).

The slope of the spillway changes three times with vertical curves in the floor of the chute (fig. 1). Piezometers were installed along the centerline of the 33.5-m (110-ft) long vertical curve immediately upstream of the stilling basin. At this point in the chute, prototype velocities of about 27 m/s (90 ft/s) are expected. Pressures were positive for all model flow conditions along the curve. However, small protrusions or bug holes in the concrete surface can cause cavitation in high velocity flows even if low pressures are not indicated in the model.

Standing waves extended downstream from the end of the pier in a diamond pattern. During free flow, the waves intersected the chute wall near the first vertical curve. For the inflow design flow flood, $Q = 940 \text{ m}^3/\text{s}$ (33 130 ft^3/s), the minimum freeboard was 3.28 m (10.75 ft) at this point. The wave intersected the right wall higher in the chute than the left wall. This was due to the asymmetrical approach to the spillway. However, the flow distribution was very uniform where it entered the stilling basin.

Subdrainage Outlets

Initially, drain outlets were to be installed on the downstream face of stilling basin chute blocks (fig. 13). However, chute blocks did not add very much stability to the hydraulic jump and would be a source of cavitation.

Pressures were measured around the fifth chute block from the left, looking upstream (fig. 13), for a range of flows. At $Q = 285 \text{ m}^3/\text{s}$ ($10\,000 \text{ ft}^3/\text{s}$), average pressures on the stilling basin floor immediately downstream from the chute block were about $+7 \text{ m}$ ($+23 \text{ ft}$) with fluctuations from -2 to $+13.7 \text{ m}$ (-6 to $+45 \text{ ft}$).³ As the discharge was increased to $375 \text{ m}^3/\text{s}$ ($13\,300 \text{ ft}^3/\text{s}$), the average pressure dropped to about atmospheric with fluctuations from -20.8 to $+18.6 \text{ m}$ (-68 to $+61 \text{ ft}$). The maximum subatmospheric pressure recorded was -32.9 m (-108 ft) at $Q = 410 \text{ m}^3/\text{s}$ ($14\,500 \text{ ft}^3/\text{s}$). The pressures listed were scaled from model to prototype; actual negative prototype pressures would be limited to the vapor pressure of water [about -8.2 m (-26.9 ft) at elevation 2100 m (6890 ft)]. As the pressure drops to vapor pressure, cavitation would occur, probably causing damage to the stilling basin.

Because chute blocks were determined to be a probable cavitation source, they were not recommended. Locations for drain outlets in the wall were then investigated. The table on figure 14 lists the measured pressures. At flows less than sweepout, the pressures were about the same as the hydrostatic pressure due to the water depth at the upstream end of the stilling basin. After sweepout, high back pressures developed on the submerged piezometers up to about 15 m (50 ft) during maximum flow. The maximum water depth after sweepout was 1.74 m (5.70 ft); therefore, it was recommended that the wall drains be located above this elevation to prevent high back pressures after sweepout.

Chute Drain Outlets

Low profile “eyebrow”-type flow deflectors were designed for the drain outlets in the chute floor to minimize danger of cavitation damage. Figure 15 shows the recommended design.

A deflector and drain (built to a 1:10 scale) were tested in the model. The dimensions of the deflector were determined by referring to previous air slot studies and the eyebrow deflectors designed by Isbester [5] for the Folsom Dam spillway. The deflectors for the 200-mm (8-in) drains

³ Pressure values are given as column height of water.

are 460 mm (18 in) long and 300 mm (12 in) wide with a 1:9 slope. The offset at the drain is 50 mm (2 in).

The maximum discharge possible in the model, 0.125 m³/s (4.4 ft³/s), simulates 140 m³/s (5000 ft³/s) in the prototype. The 0.5-m (20-in) wide model spillway simulates a 5-m (16.67-ft) wide section of the spillway. The prototype velocity simulated was about 19 m/s (62 ft/s) as compared to a maximum possible prototype velocity of 30 m/s (98 ft/s).

Air vents are required to prevent cavitation damage on the chute surface downstream from the flow deflector. Based on model measurements of air demand, the 100-mm (4-in) diameter air vents in each chute wall will have air velocities of about 60 m/s (200 ft/s) at a spillway flow of 140 m³/s (5000 ft³/s). If air demand goes up linearly with the flow velocity, the air velocity through the 100-mm (4-in) diameter vents would be about 91 m/s (299 ft/s) at the inflow design flood. When the air supply was cut off to the drain in the model, the spillway flow was drawn back into the drain.

At $Q = 140 \text{ m}^3/\text{s}$ (5000 ft³/s), the jet was deflected downstream about 2.7 times the length of the drain hole on the spillway surface; therefore, the jet will probably be deflected past the drain hole at larger flows. However, it was not possible to study larger flows at a 1:10 model scale.

Combination Stilling Basin-Flip Bucket

The stilling basin was tested over a range of flows for each design. Figure 4b is a photograph of the original design stilling basin and exit channel. Velocity and depth measurements in the model chute corresponded to a prototype Manning's n value of 0.011 at the 100-year flood flow. The original basin design and the modified designs are shown in figure 16.

Original stilling basin and flip bucket. — At the 100-year flood flow [$Q = 375 \text{ m}^3/\text{s}$ (13 300 ft³/s)], the jump remained in the basin. Waves surged over the stilling basin walls occasionally, and the jump was unstable. In the exit channel, the flow went through critical depth where it entered the original river channel. This depth control caused a hydraulic jump and could cause erosion in the prototype channel.

The flow swept out of the stilling basin at $Q = 500 \text{ m}^3/\text{s}$ (17 600 ft^3/s). However, the jet did not “flip out” into the downstream channel. As soon as the jet swept out of the basin, it impinged on the 1:5 slope moving the riprap downstream (fig. 17).

First flip bucket modification. — The angle of the flip lip was increased from 15.2 to 30° to cause the flow to flip away from the structure into the exit channel. The jump swept out of the stilling basin at a discharge of $510 \text{ m}^3/\text{s}$ (18 000 ft^3/s) (fig. 18). As soon as the jump swept out, the tailwater in the downstream channel was swept downstream. The velocity in the exit channel was very high causing violent wave action. The jet leaving the basin impinged on the slope downstream from the basin. This flow condition would cause severe erosion in the exit channel area until a plunge pool develops.

Second flip bucket modification. — In order to avoid erosion on the slope immediately downstream from the flip bucket, the lip elevation was raised to elevation 2027.83 m (6653.0 ft). A flip lip angle of 20° was used to provide a jet trajectory distance of 61 to 82 m (200 to 270 ft).

At discharges up to the 100-year flood, the hydraulic jump operated satisfactorily. However, the tailwater elevation around the basin was 0.9 to 1.2 m (3 to 4 ft) higher than in the downstream channel. The flow passed through critical depth, and a small hydraulic jump formed where the exit channel levels off at elevation 2030.9 m (6663.0 ft). The hydraulic jump turbulence in this area could cause scour. The flow swept out of the stilling basin at $395 \text{ m}^3/\text{s}$ (14 000 ft^3/s). This discharge is lower than previous designs because the flip bucket slope was more gradual and did not hold the jump in the basin as well as the more abrupt flip bucket.

The trajectory of the jet was low and still impinged on the slope downstream from the basin. Figure 19a shows the low trajectory of the jet and the high downstream velocity component of the flow in the exit channel.

Third flip bucket modification. — It was decided to increase the flip angle even though the jet will impact downstream of the outlet works channel at high flows. The flip lip was set at elevation 2027.83 m (6653.0 ft) at an angle of 37.8° .

The jump swept out of the basin at a discharge of $465 \text{ m}^3/\text{s}$ ($16\,500 \text{ ft}^3/\text{s}$). The additional capacity over the previous design was attributed to the more abrupt flip bucket. The jet from the flip bucket carried well into the downstream channel for all discharges greater than $465 \text{ m}^3/\text{s}$ ($16\,500 \text{ ft}^3/\text{s}$) (fig. 19b). Tailwater under the jet prevented the nappe from separating cleanly from the flip lip. When the flow swept out of the basin, most of the tailwater moved out of the exit channel. The jet struck the exit channel bottom and created large waves and surges. For this flow condition and exit channel configuration, a large scour hole and plunge pool would develop. Operational experiences at other structures indicate that a gravel bar may form in the downstream river causing a significant rise in tailwater at the dam. There is also the possibility of gravel and rocks being carried upstream into the outlet works stilling basin.

Exit Channel Excavation

It was decided to remove the sand and gravel overburden in the jet impact area to reduce the possibility of a gravel bar forming downstream. This change also would provide a greater tailwater depth for dissipation of energy from the jet.

This change was made in the model as shown in figure 20a. The channel banks were formed from sand and gravel to observe erosion tendencies. The channel bottom was constructed from plywood because the rate of erosion in the sandstone bottom cannot accurately be simulated in the model. The channel width downstream from the stilling basin was 18.3 m (60 ft), the same as the stilling basin width. The jump swept out of the basin at $Q = 465 \text{ m}^3/\text{s}$ ($16\,500 \text{ ft}^3/\text{s}$) when the tailwater is set according to tailwater curve (fig. 20b). After sweepout, the tailwater was depressed 1.3 m (4.3 ft). However, 5.33 m (17.5 ft) of tailwater depth remained to dissipate the energy of the jet. Figure 20c shows erosion and deposition patterns in the exit channel after sweepout. Erosion in the left bank of the spillway exit channel between the spillway and outlet works was severe. Erosion was also severe in the left bank of the outlet works channel directly in line with the spillway flow. Less severe erosion occurred in the right bank of the spillway exit channel where the excavated channel leads to the original riverbed.

With the stilling basin operating in the hydraulic jump mode, flow in the exit channel area was very smooth and the hydraulic jump was stable (fig. 20a). The tailwater elevation at the stilling

basin was the same as in the downstream channel, and wave action was less severe than in previous designs. Erosion problems in the exit channel are not anticipated for this design with the basin operating in the hydraulic jump mode.

Recommended Exit Channel Design

The floor of the exit channel was flared from 18.3 m (60 ft) wide at the end of the stilling basin to 30.5 m (100 ft) wide, 30.5 m (100 ft) downstream, to prevent erosion of the exit channel banks during flipout. This change provided a wider channel to dissipate the energy of the jet striking the tailwater. The flow swept out of the stilling basin at 465 m³/s (16 500 ft³/s). The exit channel riprap remained in place up to a flow of about 565 m³/s (20 000 ft³/s). At higher flows, the left bank of the outlet works channel, directly in line with the spillway, washed out. Damage in this area will be unavoidable during sweepout. However, this damage is far enough downstream that it should not cause any threat to the structures. The channel banks immediately downstream from the stilling basin did not erode. Deposition of gravel and debris in the outlet works stilling basin may be a problem during sweepout. However, if the outlet works and spillway are operated simultaneously, debris will be less likely to accumulate in the outlet works channel. Operation of the outlet works also helps supply tailwater to cushion the impact of the jet from the flip bucket.

Figure 21 gives curves for initial sweepout and sweepout reversal flows versus tailwater elevation. When the tailwater follows the projected curve, initial sweepout occurs at $Q = 465 \text{ m}^3/\text{s}$ (16 500 ft³/s). If the outlet works is discharging an additional 140 m³/s (5000 ft³/s), the initial sweepout occurs at a spillway flow of about 495 m³/s (17 500 ft³/s). This additional stilling basin capacity is due to increased tailwater level resulting from the outlet works flow.

After sweepout occurs, the flow will continue as a free jet until the spillway flow is decreased to about 285 m³/s (10 000 ft³/s). At this flow, the sweepout will reverse and the flow will return to the hydraulic jump. If the tailwater curve changes due to channel aggradation or degradation, the initial sweepout and sweepout reversal curves (fig. 21) should remain valid. The sweepout and sweepout reversal will occur where the changed tailwater curve crosses the sweepout curves.

After sweepout, the tailwater will be drawn down about 1 m (3 to 4 ft) due to the aspirating effect of the jet. After the initial drawdown, the tailwater may rise again if a gravel bar is formed, remain the same, or drop. It was not possible to study downstream erosion and deposition patterns in the model.

Figure 22a shows the recommended design of the stilling basin-flip bucket and exit channel; figures 22b and 23 show the recommended design operating at the 100-year flood, 375 m³/s (13 300 ft³/s). The hydraulic jump works well in dissipating the energy up to the 100-year flood. However, flows for the transition between the 100-year flood and the initial sweepout cause large waves and surges in the exit channel.

Figure 24 shows the recommended design flip bucket and exit channel operating during sweepout. The tailwater level was not drawn down as far during sweepout as in previous designs. This created a deeper plunge pool to dissipate the energy when the jet strikes the water. High tailwater prevented the bottom of the nappe from separating. The lack of air to the bottom of the jet will cause cavitation to originate at the lip of the flip bucket. However, this should not cause any damage because the vapor cavities should collapse in the flow downstream from the stilling basin.

The photographs in figure 24 show the full range of sweepout flows. Figure 24a shows an initial sweepout flow without the outlet works operating. In figure 24b, the outlet works is operating in addition to the spillway. The outlet works flow reduces the turbulence downstream from the jet impact area and turns the flow direction slightly.

Figure 24c shows the inflow design flood discharging through the spillway and outlet works.

The difference in the height and length of the jet over the range of sweepout flows is illustrated in figure 24. The turbulence downstream from the jet impact area is considerably more for the inflow design flood (fig. 24c) than for initial sweepout (fig. 24b). However, the downstream turbulence for the recommended design is considerably less severe than in earlier designs (figs. 17, 18, and 19).

Table 1 contains data describing water surface profiles and dimensions of the jet during sweepout. Figure 25 is a plan of the recommended design exit channel showing model limits and a length scale. For the inflow design flood, the jet will travel about 125 m (415 ft) downstream from the flip lip and will be 39 m (128 ft) high (above the exit channel floor).

Stilling Basin Debris Tests

A series of tests was conducted to determine the self-cleaning characteristics of the recommended stilling basin. These tests should be useful in determining the flow required to clean the basin for various sizes of debris that may accumulate in the basin.

Test procedure. — Rocks of various sizes and shapes (see table 2) were placed in the stilling basin (fig. 26a). The flow was then gradually increased to the test flow and held constant for a period of 45 minutes (4.5 hours prototype time). The flow was then stopped and the location and number of debris pieces were noted and photographed.

Results. — Table 2 lists the results of the debris tests. At a discharge of 140 m³/s (5000 ft³/s), the debris shifted to the base of the flip bucket; however, none of the debris washed out (fig. 26b). At a discharge of 200 m³/s (7000 ft³/s), about half of the 75-mm (3-in) rocks, one 0.3-m (1-ft) rock, and one 0.9-m (3-ft) rock were washed out. These rocks had a tendency to deposit immediately downstream from the center of the flip lip (fig. 26c). At a discharge of 255 m³/s (9000 ft³/s), all the debris except a few 1.5-m (5-ft) rocks were washed out of the basin. The test at a discharge of 255 m³/s (9000 ft³/s) was repeated to verify the results.

The deposition area immediately downstream from the flip lip indicates that a reverse roller exists at the end of the basin. This roller may tend to draw debris into the basin at low flows, although no rocks were drawn into the basin during the testing.

As the flow is increased, the length of the jump in the basin increases. At 255 m³/s (9000 ft³/s), the jump extends far enough downstream to wash most of the rocks out of the basin.

Table 1.—Combination stilling basin-flip bucket flow data

Q ¹ spillway discharge m ³ /s (ft ³ /s)	Average water surface elevation in stilling basin			L ³ Length of leading edge of jet	H ⁴ Maximum height of jet	L - Distance at H	Tailwater elevation		
	At L1 ²	At L2	At L3				At stilling basin	At outlet works	In downstream channel
140 (5 000)	2031.8 (6666.0)	2032.1 (6667.0)	2032.4 (6668.0)	- -	- -	- -	2032.3 (6667.6)	2032.7 (6669.0)	2032.1 (6667.5)
285 (10 000)	2030.0 (6660.0)	2031.2 (6665.0)	2033.3 (6671.0)	- -	- -	- -	2032.9 (6670.8)	2033.2 (6670.5)	2033.0 (6669.8)
370 (13 000)	2027.2 (6651.0)	2030.0 (6660.0)	2031.8 (6666.0)	- -	- -	- -	2033.3 (6670.8)	2033.6 (6672.0)	2033.3 (6671.0)
455 (16 000)	2023.0 (6637.0)	2022.7 (6636.0)	2022.3 (6635.0)	76.2 (250)	17.7 (58)	36.6 (120)	2031.8 (6666.0)	2031.0 (6663.5)	2031.8 (6666.0)
565 (20 000)	2023.0 (6637.0)	2023.4 (6638.5)	2022.3 (6635.0)	99.1 (325)	21.9 (72)	48.8 (160)	2031.8 (6666.0)	2031.0 (6663.5)	2031.8 (6666.0)
710 (25 000)	2023.3 (6638.0)	2023.9 (6640.0)	2022.7 (6636.0)	106.7 (350)	26.8 (88)	54.9 (180)	2031.8 (6666.0)	2030.9 (6663.0)	2031.8 (6666.0)
940 (33 130)	2023.6 (6639.0)	2024.9 (6643.5)	2023.3 (6638.0)	126.5 (415)	39.0 (128)	64.0 (210)	2032.3 (6667.5)	2032.1 (6667.0)	2032.3 (6667.5)

17

NOTES: All distances and elevations in meters (feet). See figure 25 for plan of exit channel.

¹Outlet works discharging 150 m³/s (5260 ft³/s) in addition to spillway flow.

²L1 at -39.6 m (-130 ft), L2 at -30.5 m (-100 ft), L3 at -15.2 m (-50 ft).

³Lengths are horizontal distances from the flip lip.

⁴Heights are vertical distances above exit channel elevation 2026.9 m (6650 ft).

Table 2. — *Stilling basin debris tests—Number of rocks in basin after test*

Discharge m ³ /s (ft ³ /s)	Size of rocks ¹ (diameter)			
	75 mm (3 in)	300 mm (1 ft)	900 mm (3 ft)	1500 mm (5 ft)
Before test	45	9	20	10
140 (5000)	45	9	20	10
200 (7000)	20	8	19	10
255 (9000)	0	0	0	1
255 (9000)	0	0	0	4

¹ Rock sizes scaled geometrically. Model rock diameter = (1/36) prototype diameter.

Notes:

- Duration of tests was 4.5 hours (45 minutes model time).
- See figure 26 for distribution of rocks in basin.
- Conversion approximations: 1 ft = 300 mm, 1 in = 25 mm.

BIBLIOGRAPHY

- [1] Graf, W. H., "Hydraulics of Sediment Transport," McGraw-Hill, Inc., 1971.
- [2] Falvey, H. T., "Air-Water Flow in Hydraulic Structures," Engineering Monograph No. 41, U.S. Department of the Interior, Water and Power Resources Service, 1980.
- [3] Chow, V.T., "Open Channel Hydraulics," McGraw-Hill, Inc., 1959.
- [4] "Design of Gravity Dams" U.S. Department of the Interior, Bureau of Reclamation, Denver, Colo., 1976.
- [5] Isbester, T. J., "Hydraulic Model Studies of Folsom Spillway-Outlet Junction," REC-ERC-71-12, U.S. Department of the Interior, Bureau of Reclamation, February 1971.

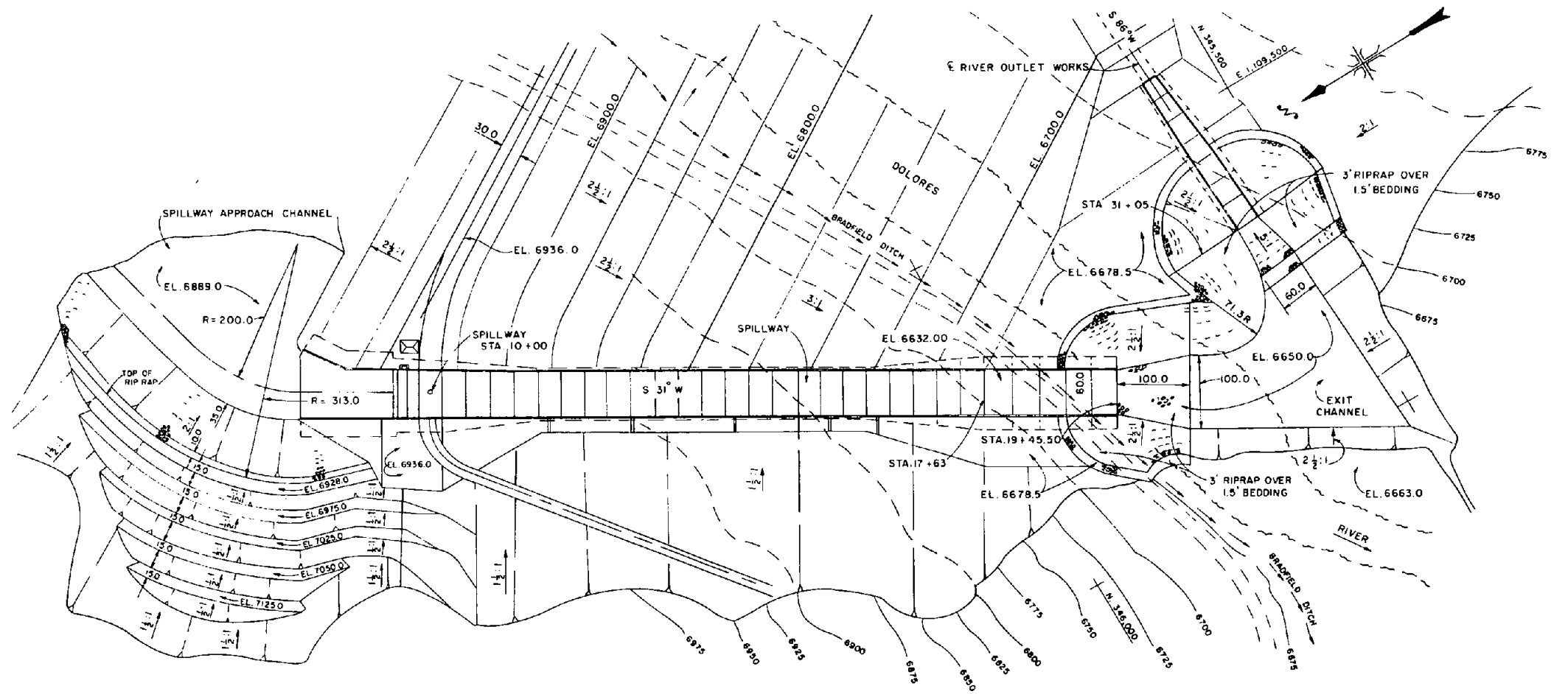

PLAN

ALL DIMENSIONS IN FEET
1 FOOT = 0.3048 METER

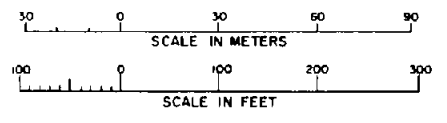
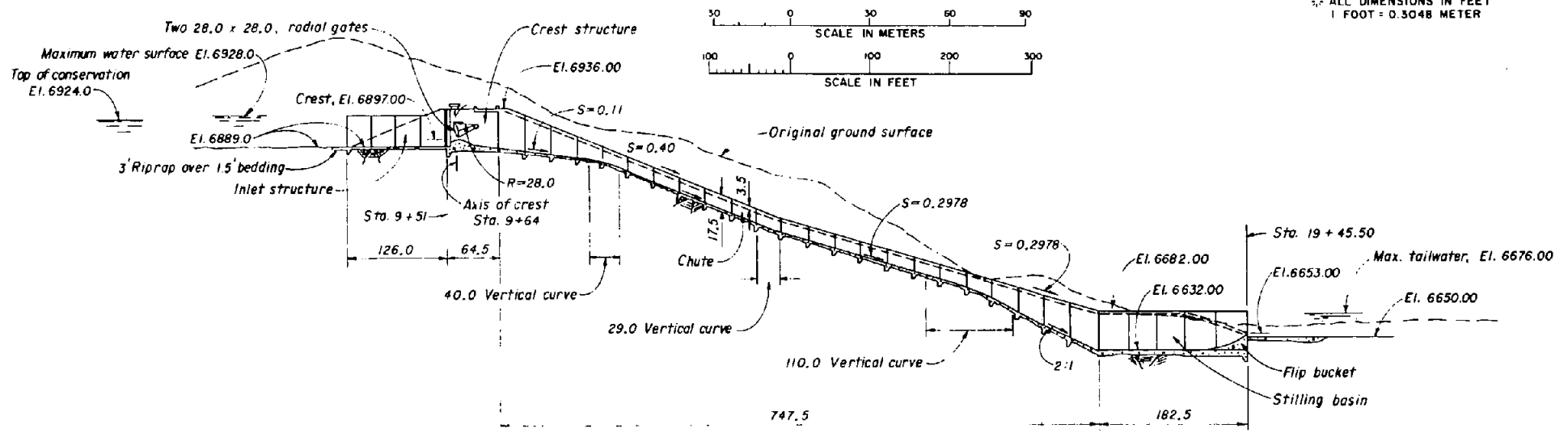
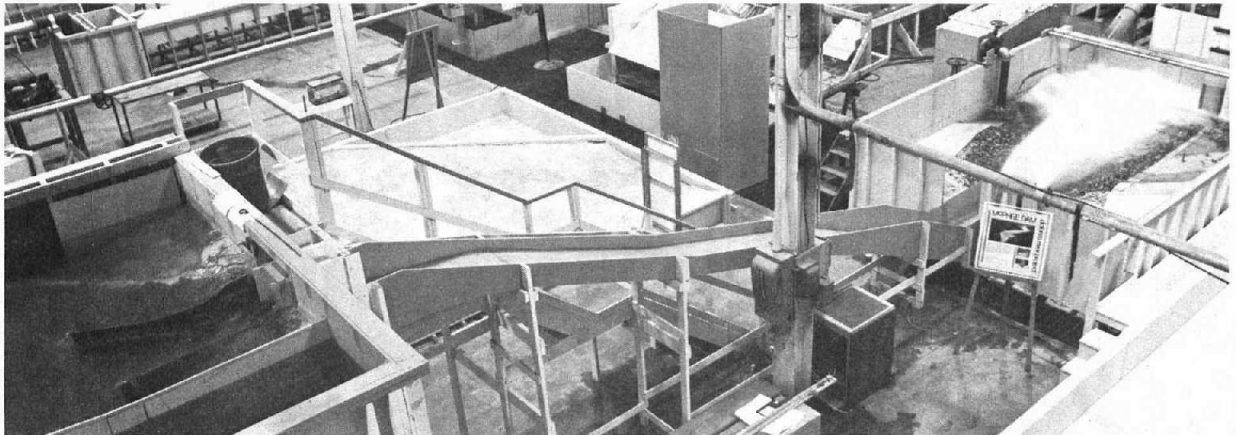

Figure 1.—Plan and profile of spillway



Recommended Design: $Q = 940 \text{ m}^3/\text{s}$ (33 130 ft^3/s), approach channel, spillway crest, chute spillway, combination hydraulic jump stilling basin-flip bucket, and exit channel.

Figure 2.-McPhee Dam spillway model in operation. Photo P801-D-79446

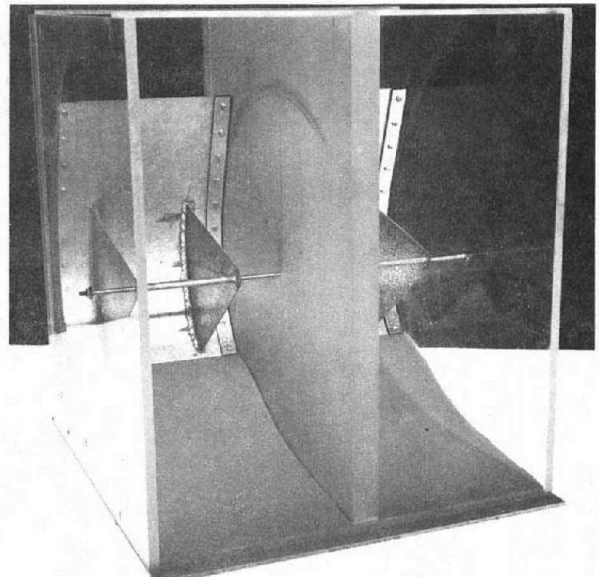
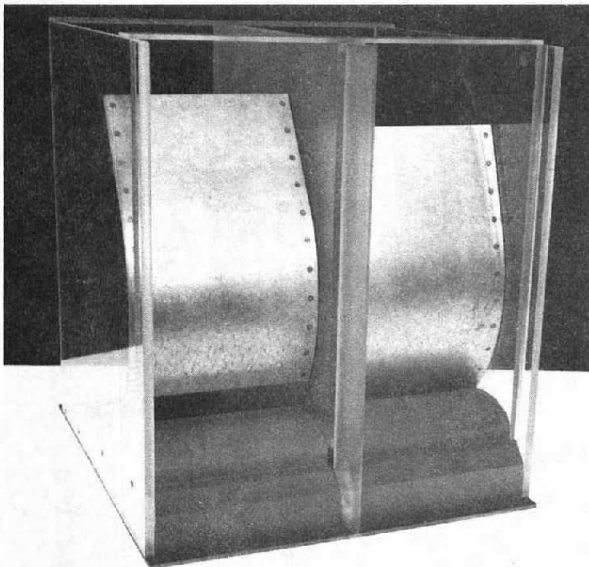
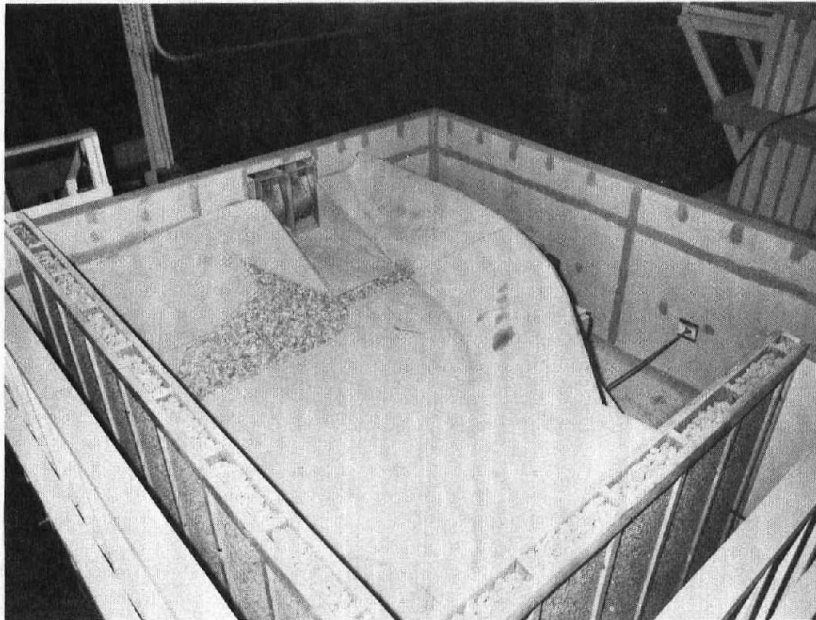
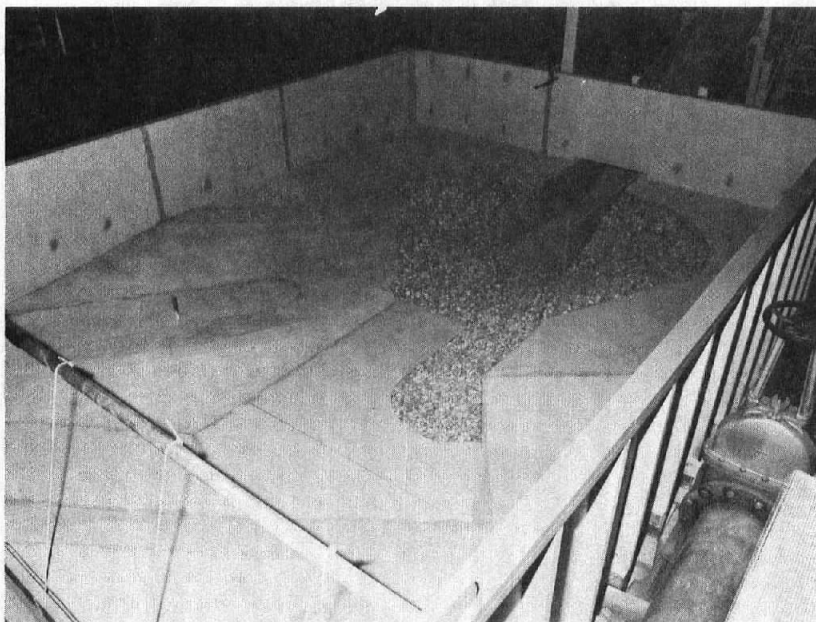

Figure 3.-Model spillway crest structure and radial gates. Photo P801-D-79447



a. Approach channel — Sloping guide walls leading to the spillway. Photo P801-D-79448



b. Exit Channel - Downstream channel sloping up at 5:1 slope from the stilling basin to the river channel. Photo P801-D-79449

Figure 4. Preliminary design approach channel and exit channel.

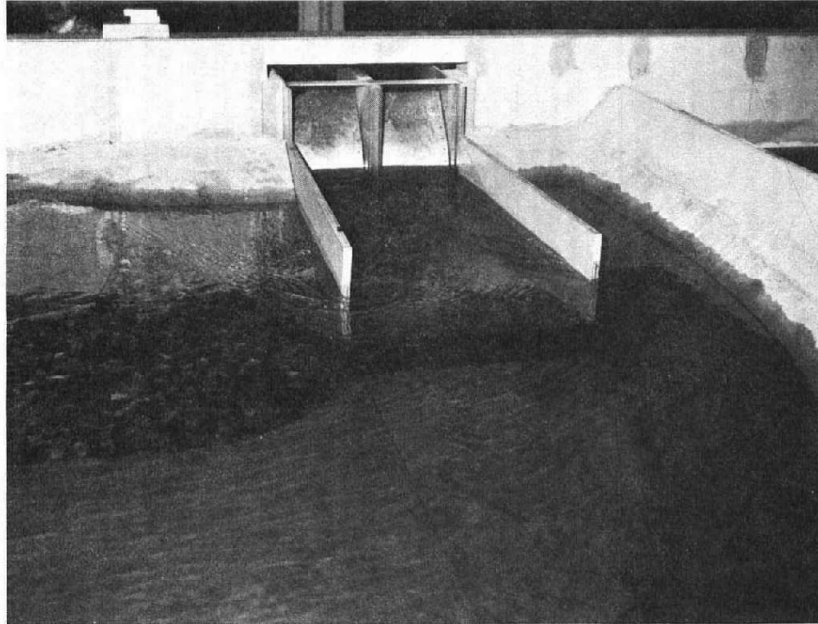

a. Guide walls raised above the maximum water surface (position of the walls is the same as in the preliminary design), $Q = 375 \text{ m}^3/\text{s}$ ($13\,300 \text{ ft}^3/\text{s}$). Photo P801-D-79450



b. Curved guide walls added, $Q = 650 \text{ m}^3/\text{s}$ ($23\,000 \text{ ft}^3/\text{s}$). Photo P801-D-79451

Figure 5.-Approach channel modification No. 1



a. Short curved guide walls, radius = 15.24 m (50 ft), leading to spillway.
Photo P801-D-79452



b. $Q = 940 \text{ m}^3/\text{s}$ (33 130 ft^3/s), reservoir elevation = 2111.25 m (6926.7 ft).
Photo P801-D-79453

Figure 6.-Approach channel modification No. 2

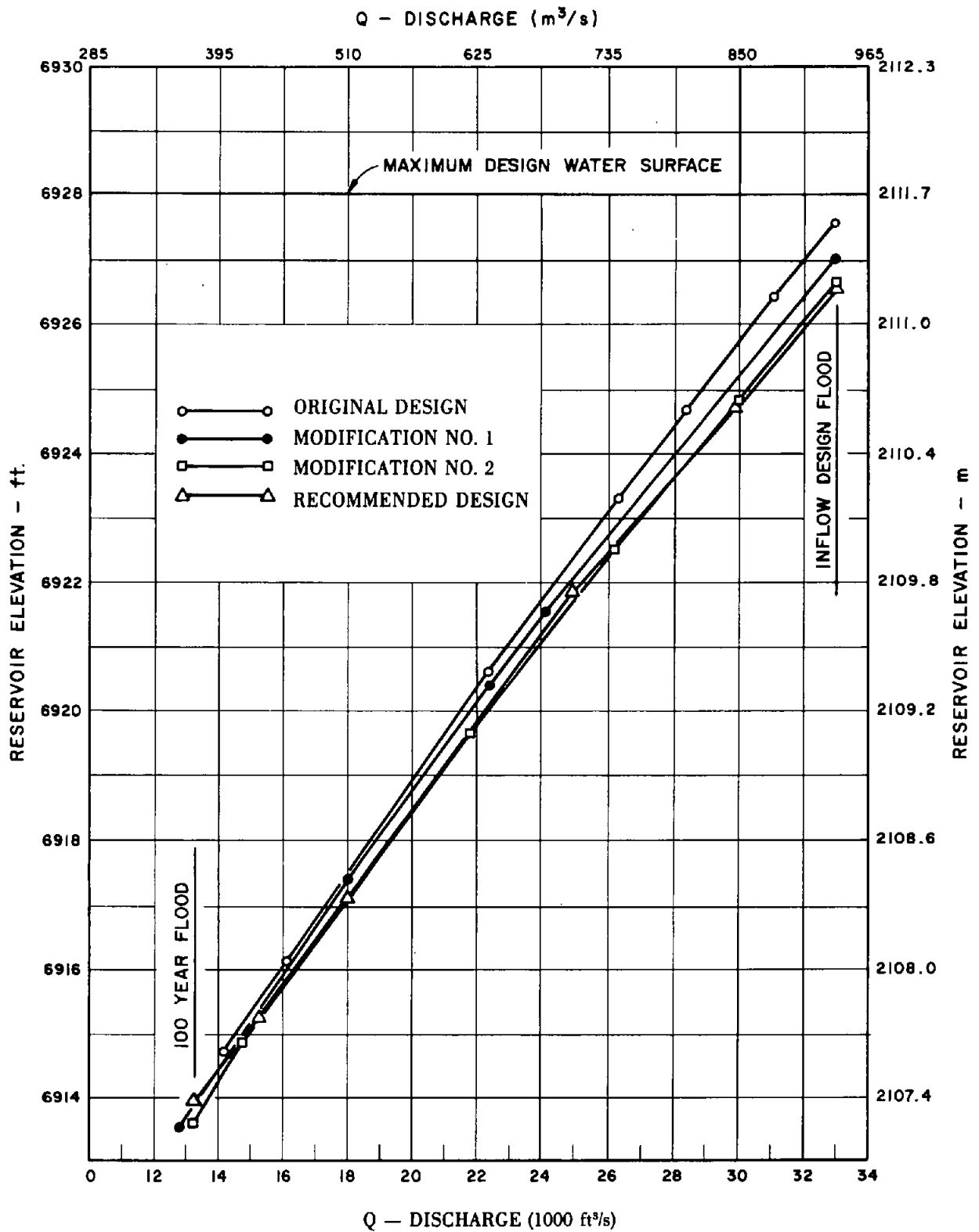
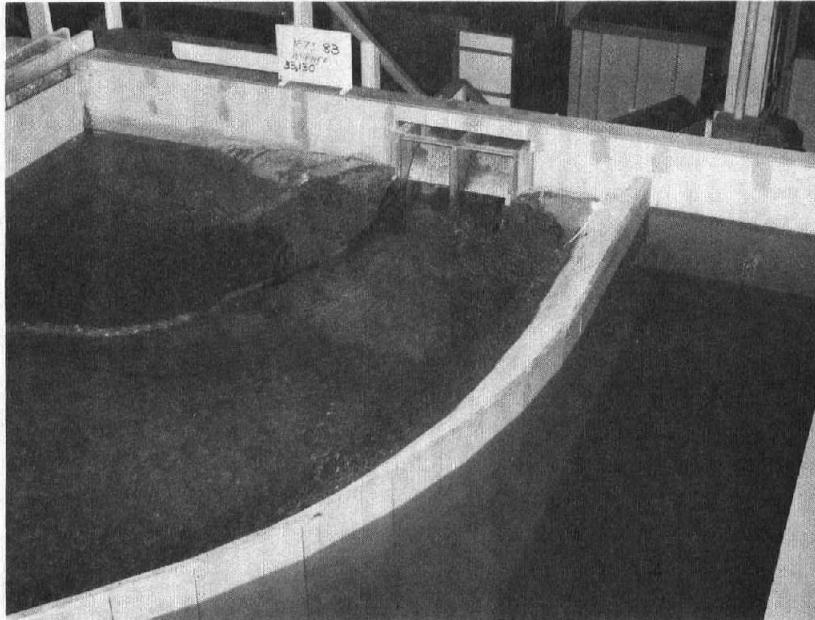
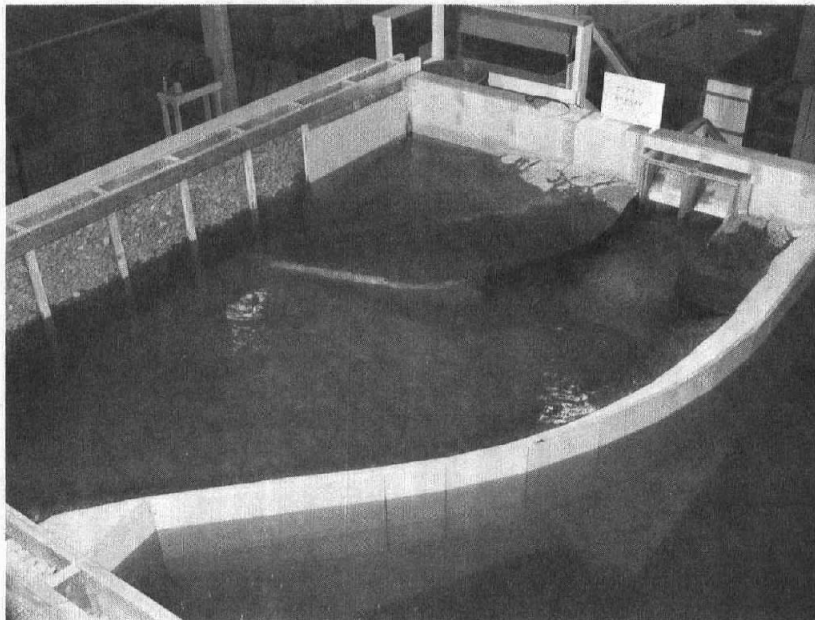

Figure 7.-Discharge versus reservoir elevation for nongated flow (free flow).



a. Left wall flares out guiding flow into the spillway. Right wall slopes (same as preliminary design), $Q = 940 \text{ m}^3/\text{s}$ (33 130 ft^3/s), reservoir elevation = 2111.38 m (6927.09 ft). Photo P801-D-79434



b. Right wall curving toward cut slope, $Q = 940 \text{ m}^3/\text{s}$ (33 130 ft^3/s), reservoir elevation = 2111.23 m (6926.6 ft). Photo P801-D-79455

Figure 8.-Approach channel modification No. 3



a. $Q = 375 \text{ m}^3/\text{s}$ (13 300 ft^3/s), 100-year flood, reservoir elevation = 2110.97 m (6925.75 ft), gate opening = 2.62 m (8.6 ft). Photo P801-D-79456



b. $Q = 940 \text{ m}^3/\text{s}$ (33 130 ft^3/s), inflow design flood, reservoir elevation = 2111.23 m (6926.6 ft). Photo P801-D-79457

Figure 9.-Recommended approach channel

MOPHEE DAM RATING CURVES (BOTH GATES)

△ = FREE FLOW
 □ = GATED FLOW

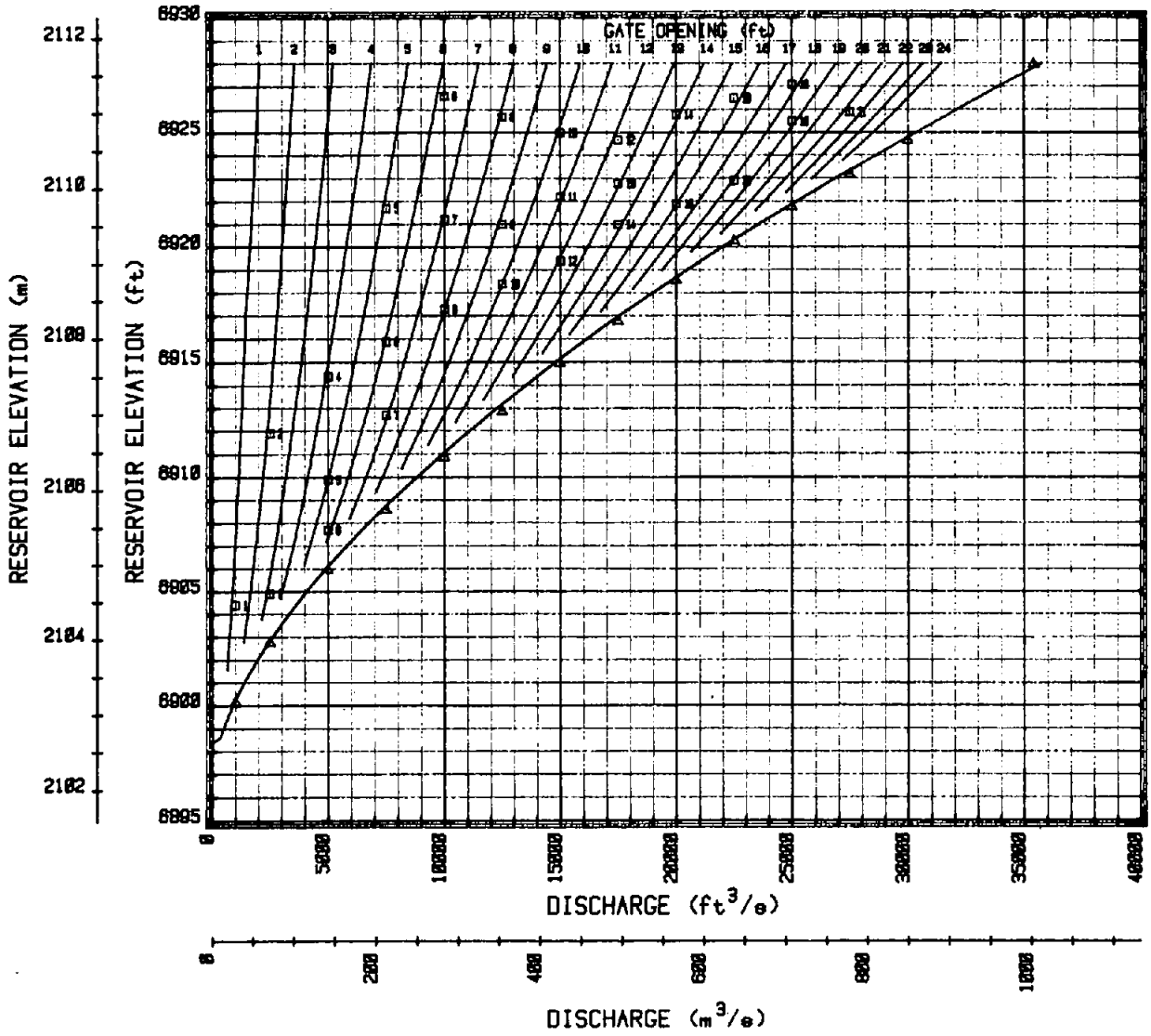

Figure 10. Spillway rating curves - two gates

McPHEE DAM RATING CURVES (LEFT GATE)

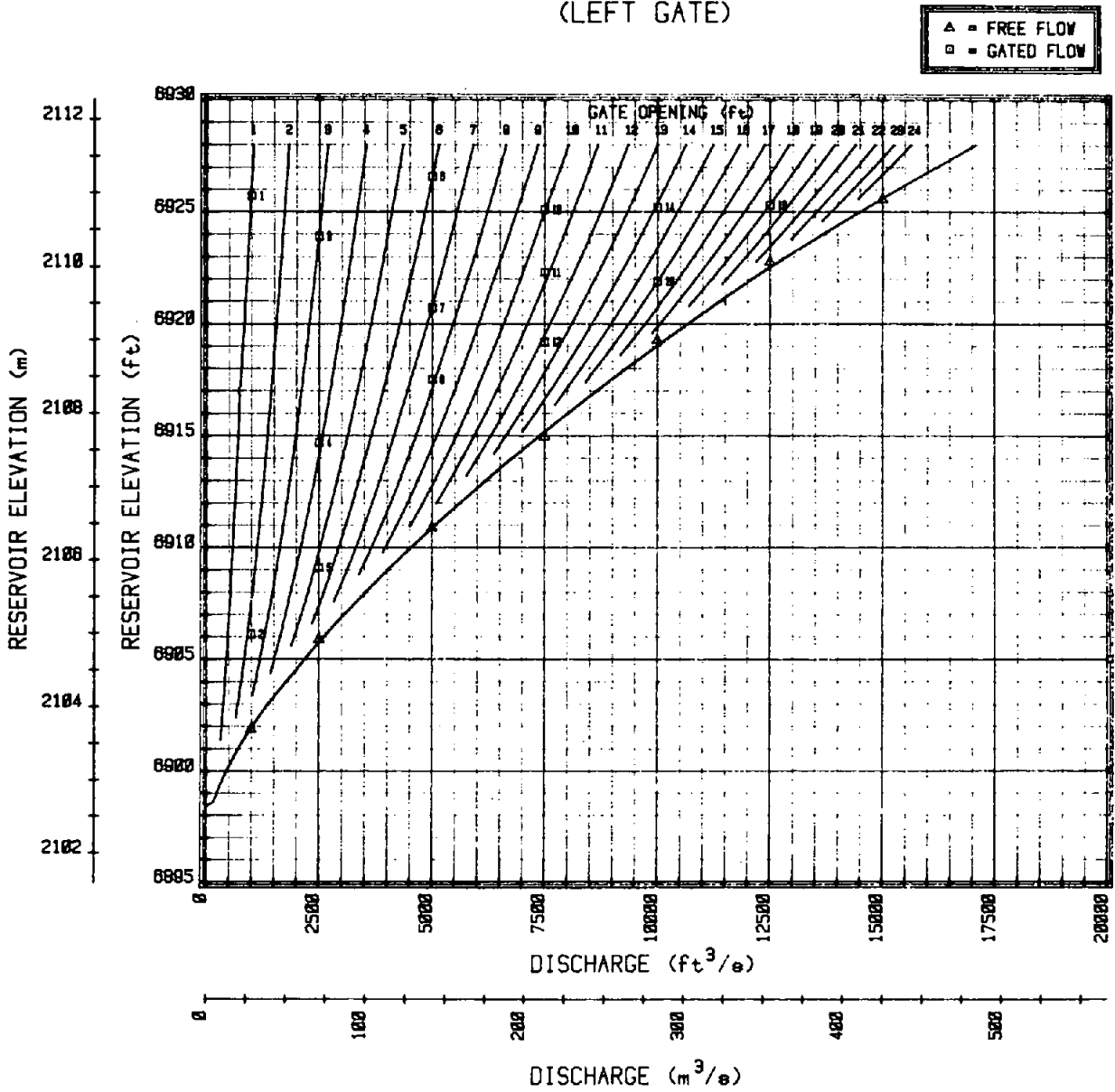

Figure 11. Spillway rating curves - left gate

MOPHEE DAM RATING CURVES (RIGHT GATE)

= FREE FLOW
 = GATED FLOW

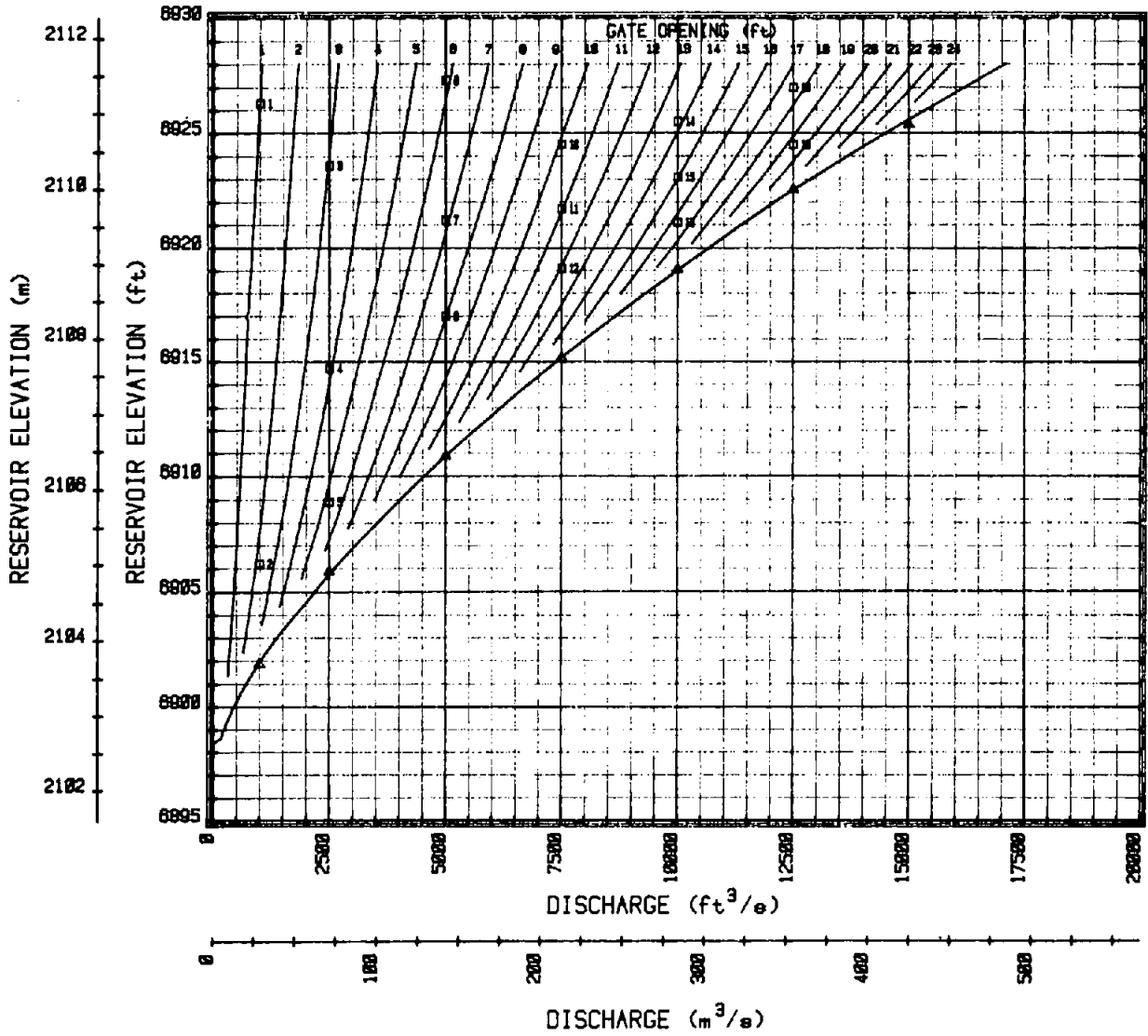
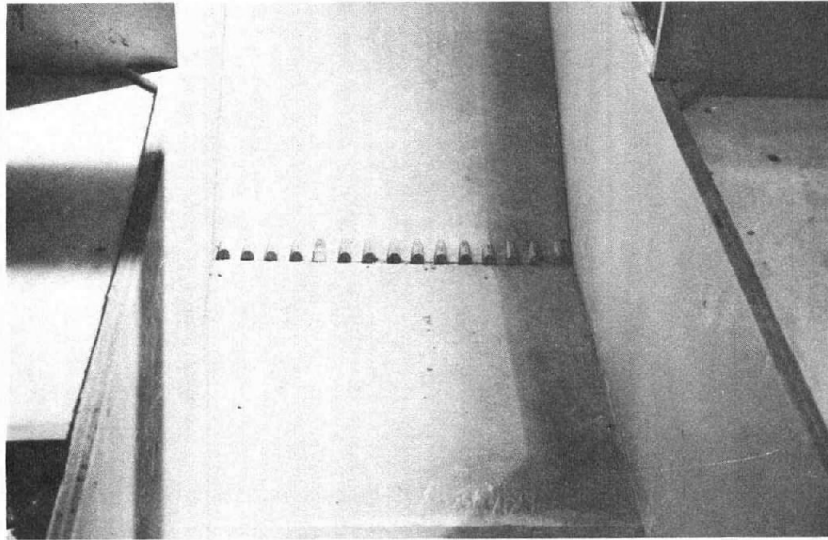
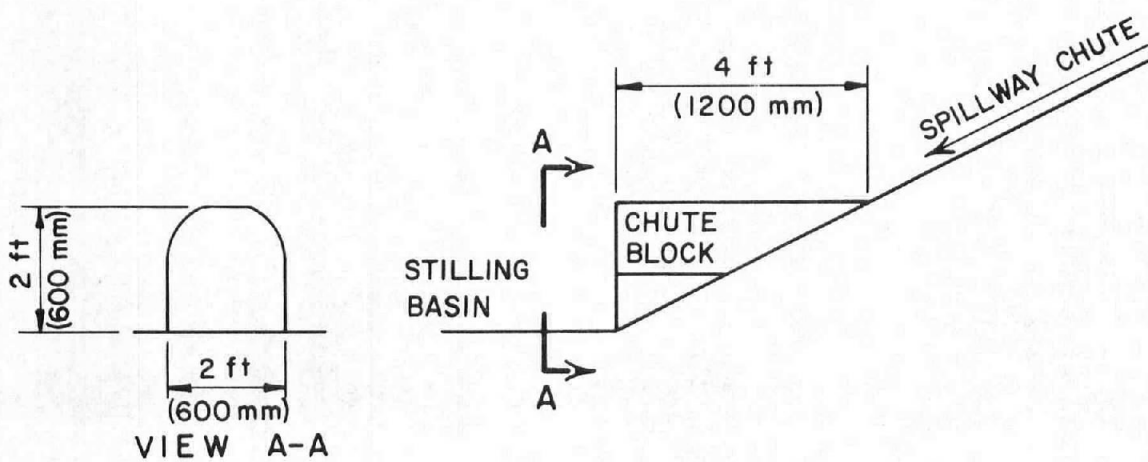

Figure 12.-Spillway rating curves - right gate



a. Fifteen chute blocks installed at the intersection of the spillway chute and stilling basin. Photo P801-D-79458



b. Chute block detail

Figure 13.-Chute blocks

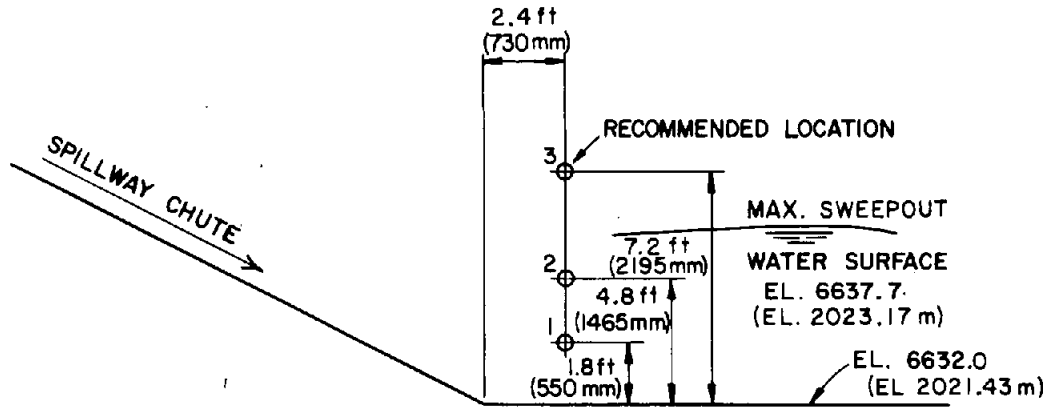

POTENTIAL WALL DRAIN OUTLET LOCATIONS

DISCHARGE		PIEZOMETERS			
m ³ /s	ft ³ /s	1 AVG	1 FLUC	2 AVG	3 AVG
140	5 000	8.99 (29.5)	±2.07 (±6.8)	8.14 (26.7)	6.95 (22.8)
285	10 000	9.54 (31.3)	±4.18 (±13.7)	7.83 (25.7)	5.73 (18.8)
375	13 300	8.11 (26.6)	±8.66 (±28.4)	5.70 (18.7)	2.38 (7.8)
435	15 300	5.49 (18.0)	±0.98 (±3.2)	1.89 (6.2)	-0.06 (-0.2)
455	16 000	6.04 (19.8)	±3.72 (±12.2)	*	*
510	18 000	7.13 (23.4)	±2.62 (±8.6)	*	*
565	20 000	10.09 (33.1)	±3.60 (±11.8)	*	*
710	25 000	10.85 (35.6)	±3.29 (±10.8)	*	*
850	30 000	12.62 (41.4)	±3.72 (±12.2)	*	*
940	33 130	14.14 (46.4)	±3.08 (±10.1)	10.12 (33.2)	*

*Drain above water surface (after sweepout)
Pressures in meters of water (feet of water)

WALL DRAIN PRESSURES

Figure 14.-Wall drains

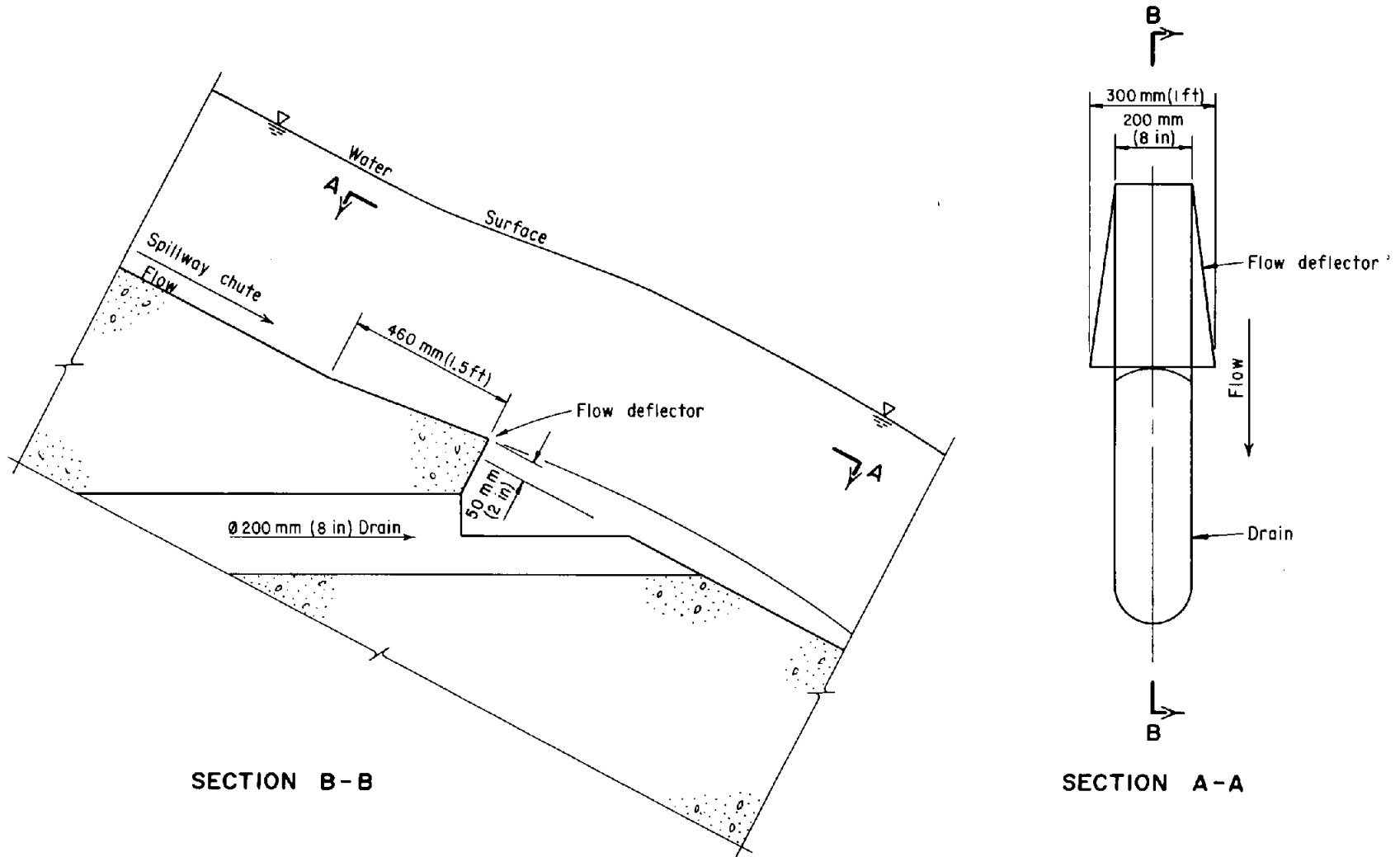
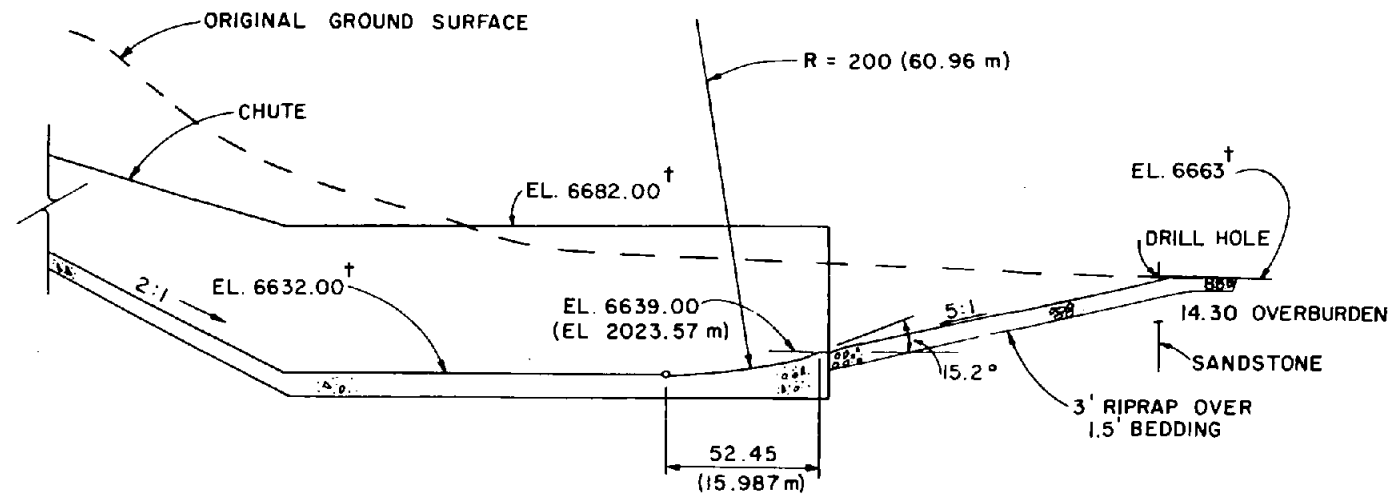
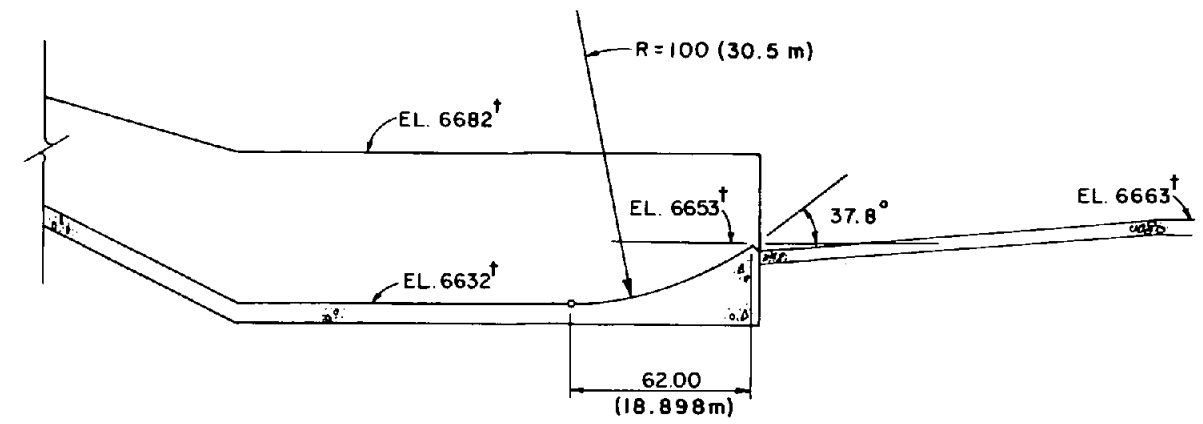

Figure 15.-Flow deflector and chute drain outlet



a. ORIGINAL STILLING BASIN AND FLIP BUCKET



d. THIRD FLIP BUCKET MODIFICATION

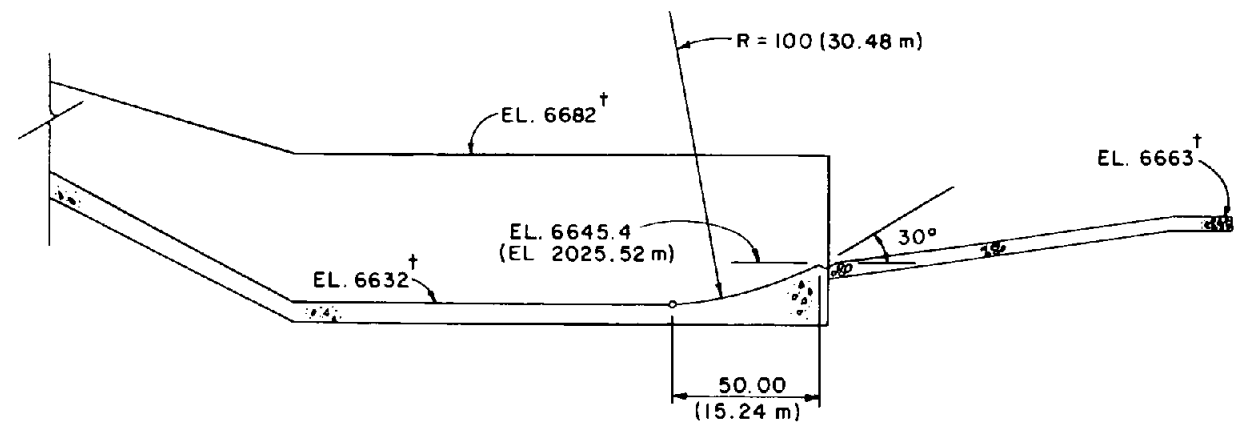

b. FIRST FLIP BUCKET MODIFICATION

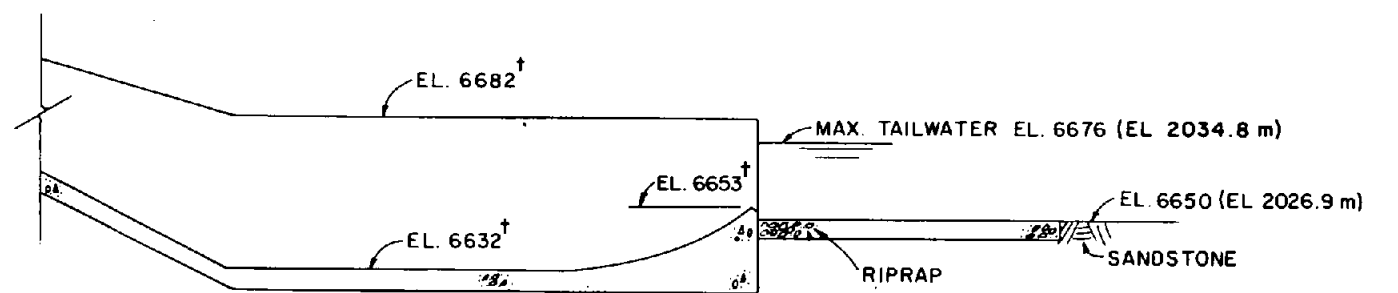

e. THIRD FLIP BUCKET MODIFICATION WITH EXIT CHANNEL EXCAVATED TO SANDSTONE (RECOMMENDED DESIGN)

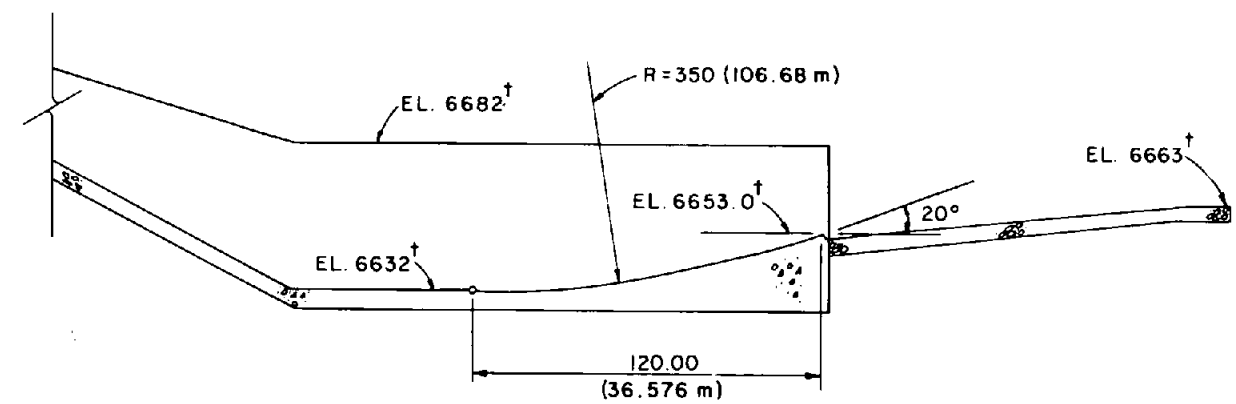

c. SECOND FLIP BUCKET MODIFICATION

* ALL DISTANCES AND ELEVATIONS IN FEET (METERS)
 † EL. 6632 ft = EL 2021.4 m EL. 6682 ft = EL 2036.7 m
 EL. 6663 ft = EL 2030.9 m EL. 6653 ft = EL 2027.8 m

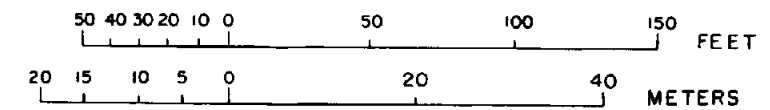
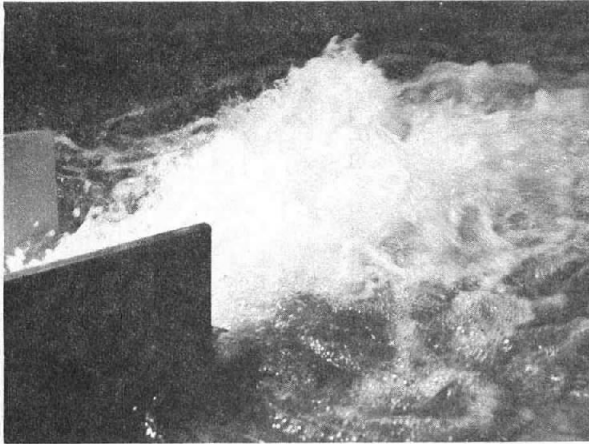
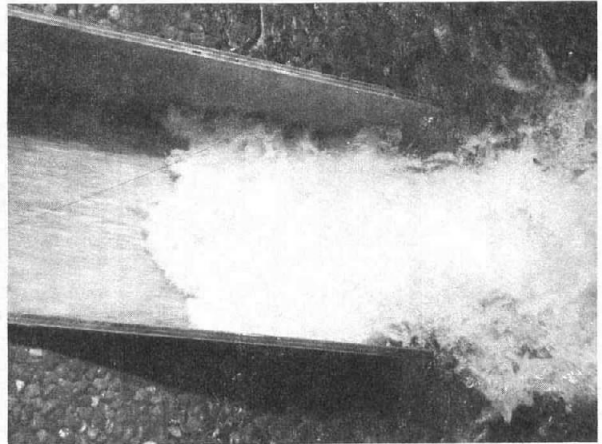

Figure 16.-Stilling basin-flip bucket profiles



a. Flow sweeping out of stilling basin at $Q = 500 \text{ m}^3/\text{s}$ (17 600 ft^3/s) and impinging on downstream slope. Photo P801-D-79459



b. Jump sweeping out of stilling basin. Photo P801-D-79461



c. Downstream channel during sweepout. Photo P801-D-79462

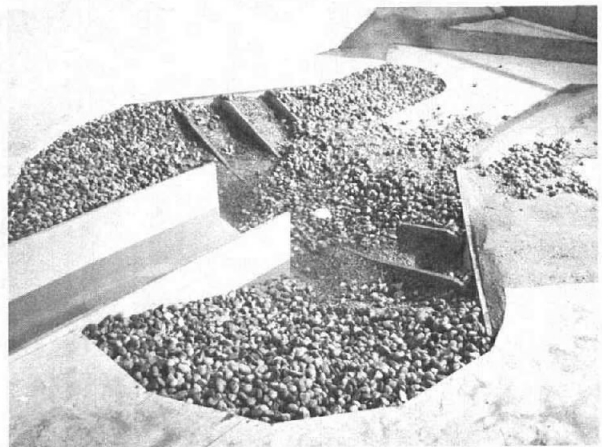

d. Erosion in exit channel after sweepout for a few seconds. Photo P801-D-79460

Figure 17.-Original design stilling basin operation and erosion

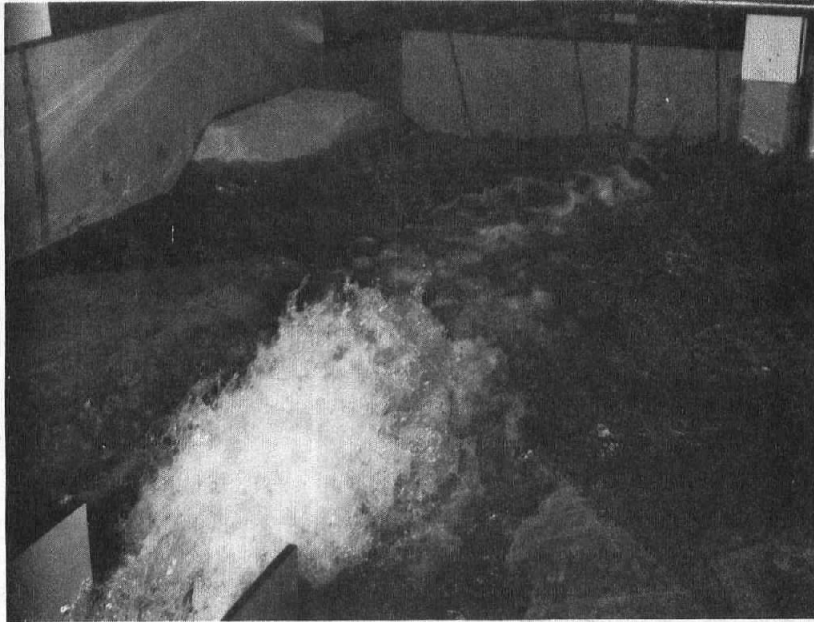

a. Initial sweepout, $Q = 510 \text{ m}^3/\text{s}$ (18 000 ft^3/s). Photo P801-D-79463



b. Exit channel at $Q = 510 \text{ m}^3/\text{s}$ (18 000 ft^3/s). Tailwater is washed out and velocity is very high at the model tailgate. Photo P801-D-79464

Figure 18.-Flip bucket modification No. 1 operating

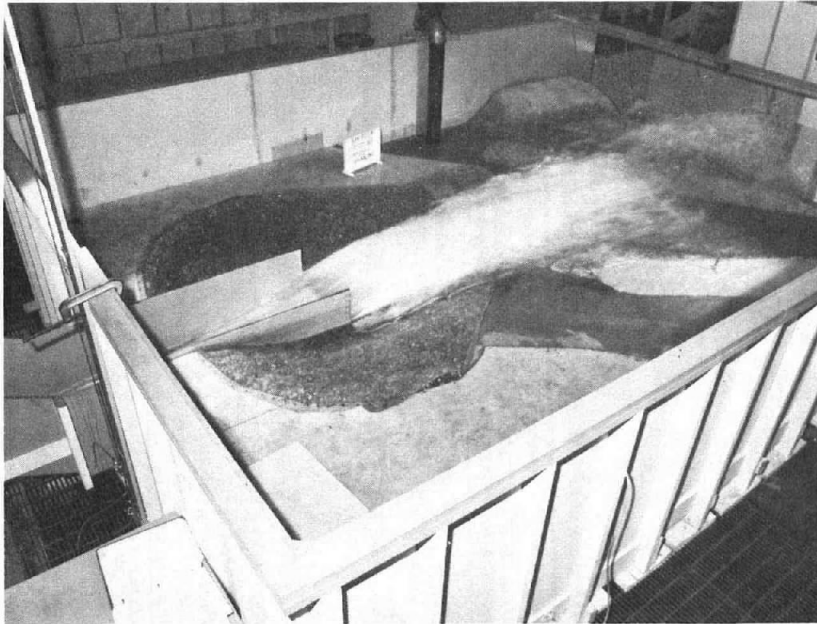

a. Modification No. 2, $Q = 940 \text{ m}^3/\text{s}$ (33 130 ft^3/s), flip angle = 20° . Photo P801-D-79465

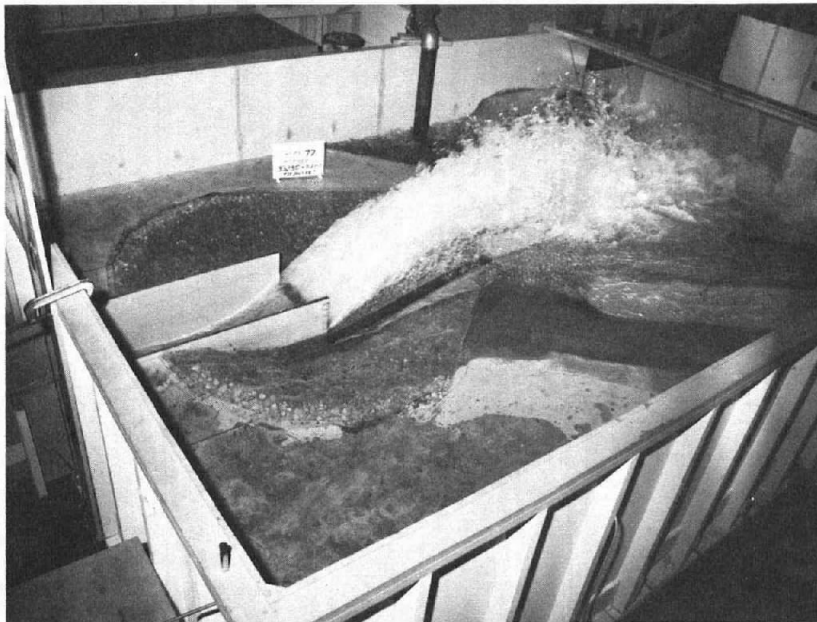

b. Modification No. 3, $Q = 940 \text{ m}^3/\text{s}$ (33 130 ft^3/s), flip angle = 37.8° . Photo P801-D-79466

Figure 19.-Flip bucket modifications No. 2 and 3 operating

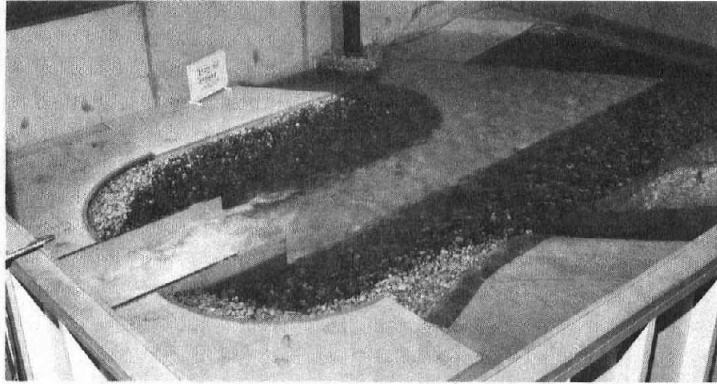

a. Hydraulic jump operation at $Q = 375 \text{ m}^3/\text{s}$ (13 300 ft^3/s). Photo P801-D-79467

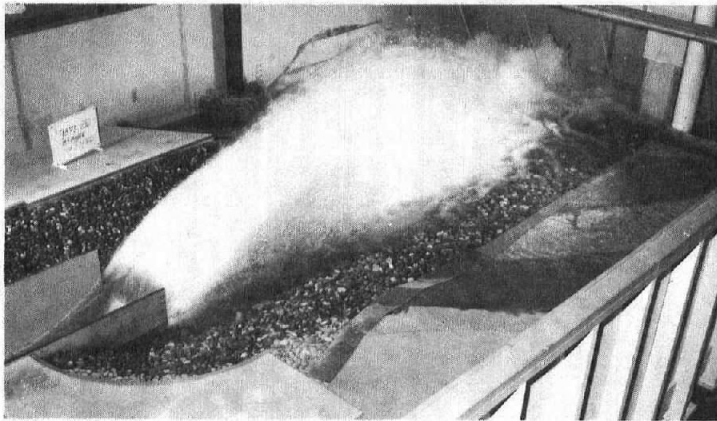

b. $Q = 940 \text{ m}^3/\text{s}$ (33 130 ft^3/s). Photo P801-D-79468

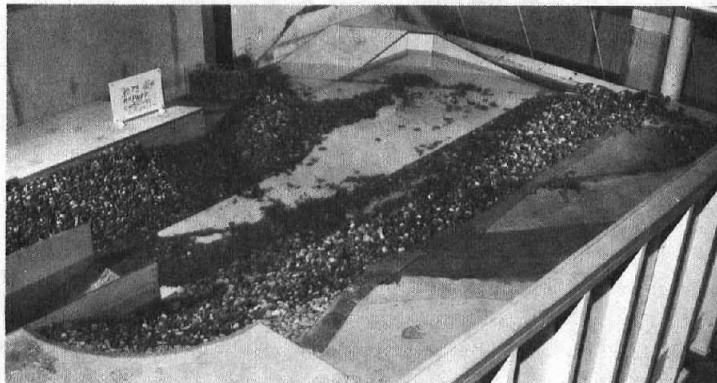

c. Channel bank erosion after operation at $Q = 940 \text{ m}^3/\text{s}$ (33 130 ft^3/s) for about 1 hour. Photo P801-D-79469

Figure 20. Flip bucket modification No. 3 with exit channel modification.

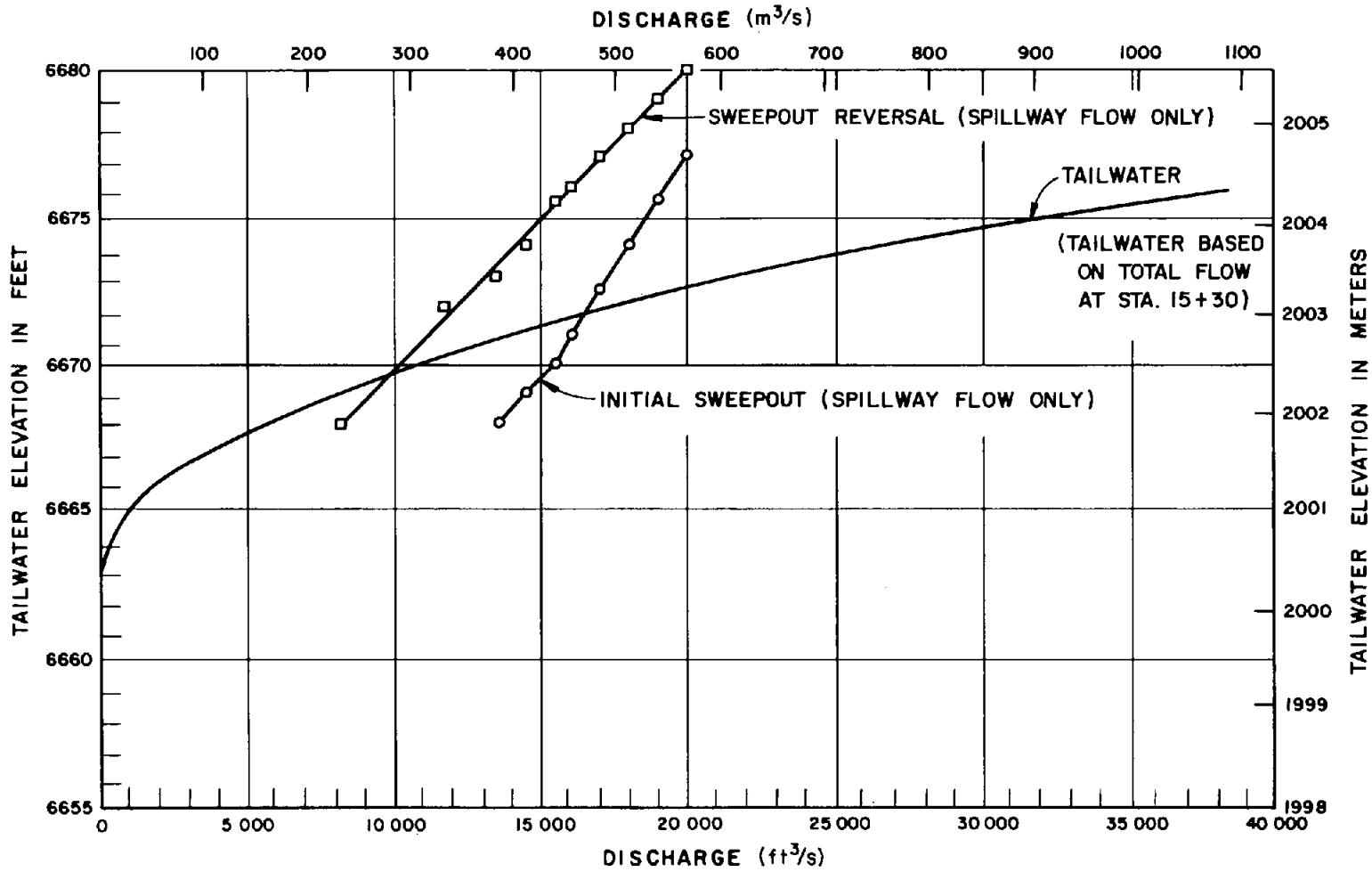
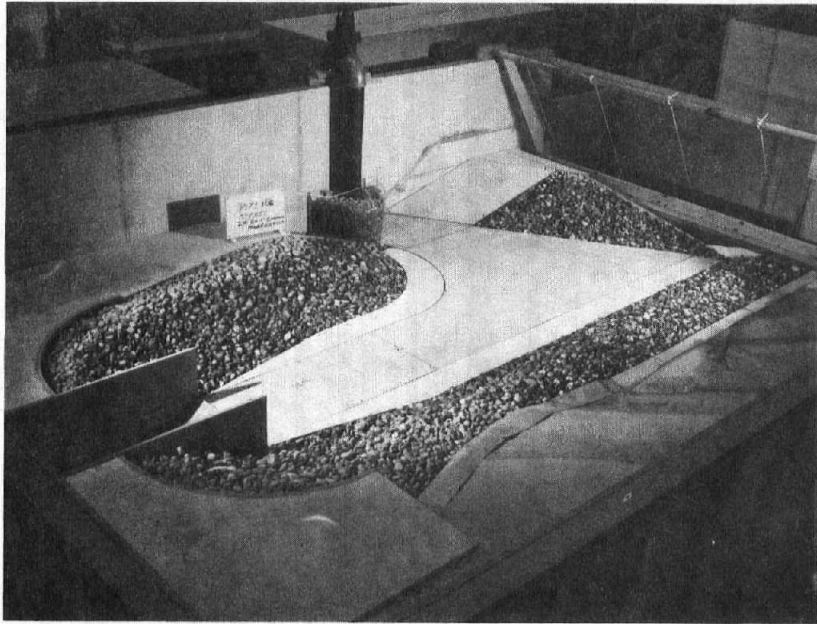

Figure 21.-Initial sweepout and sweepout reversed versus tailwater curve



a. Exit channel. Photo P801-D-79470



b. Exit channel looking downstream, $Q = 375 \text{ m}^3/\text{s}$ (13 300 ft^3/s). Photo P801-D-79471

Figure 22.-Recommended exit channel

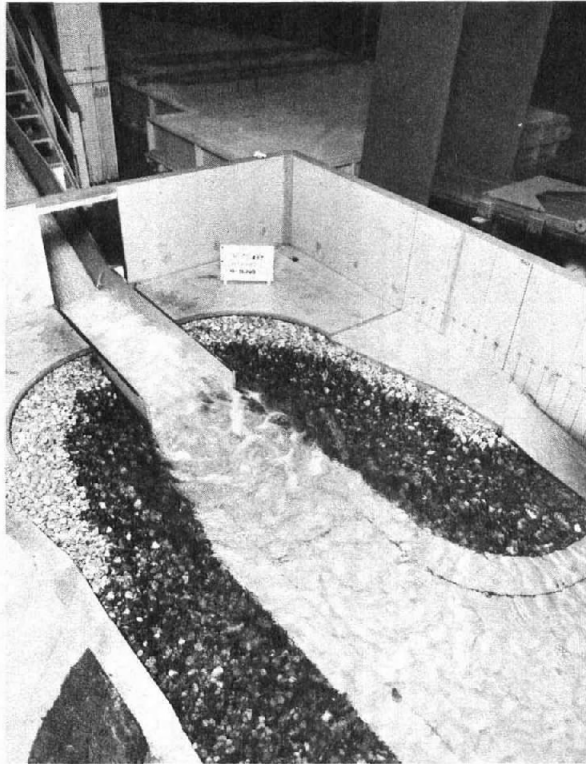

a. $Q = 375 \text{ m}^3/\text{s}$ (13 300 ft^3/s). Photo P-801-D-79472

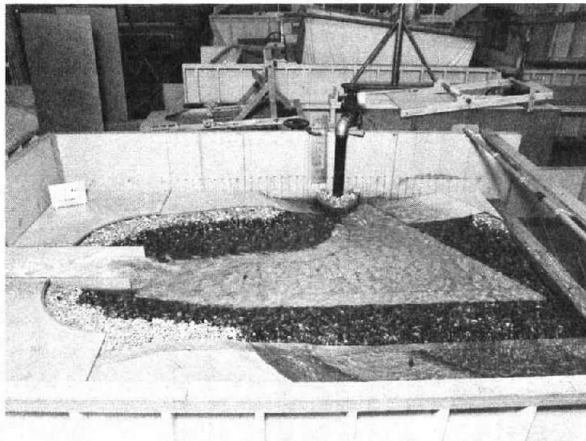

b. $Q = 375 \text{ m}^3/\text{s}$ (13 300 ft^3/s). Photo P-801-D-79473

Figure 23.-Recommended exit channel and stilling basin operating

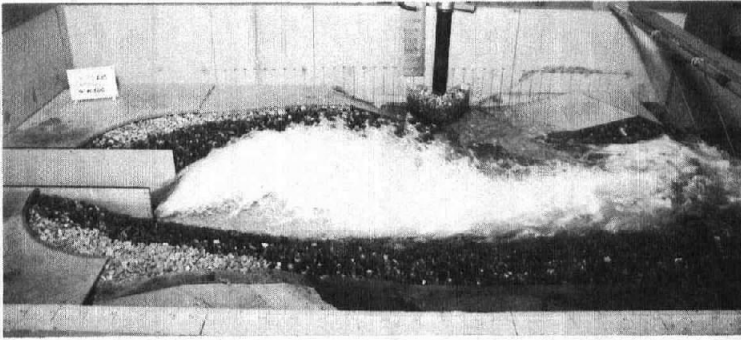

a. $Q = 465 \text{ m}^3/\text{s}$ (16 500 ft^3/s), no outlet works flow. Photo P801-D-79474

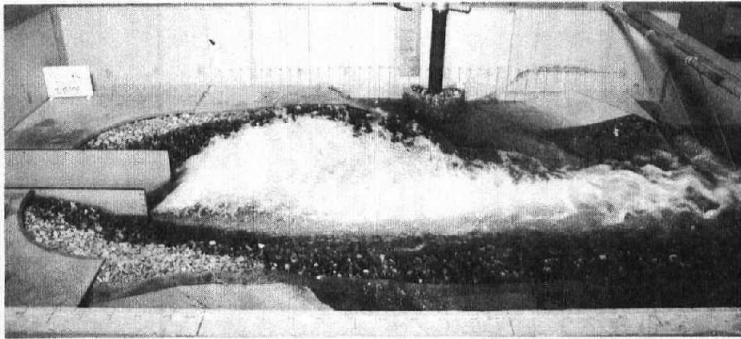

b. $Q = 465 \text{ m}^3/\text{s}$ (16 500 ft^3/s) with 150 m^3/s (5260 ft^3/s) outlet works flow. Photo P801-D-79475

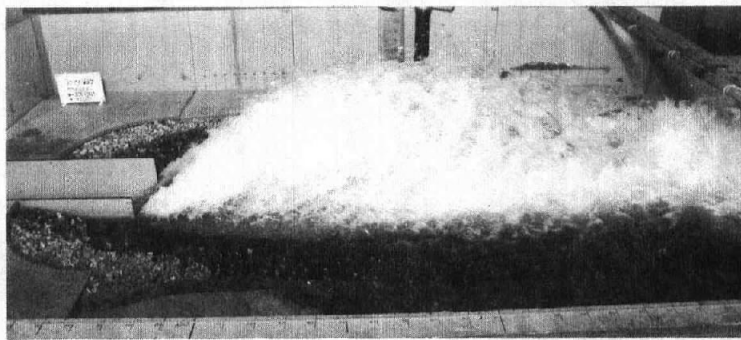

c. $Q = 940 \text{ m}^3/\text{s}$ (33 130 ft^3/s) with 150 m^3/s (5260 ft^3/s) outlet works flow (inflow design flood). Photo P801-D-79476

Figure 24.-Recommended stilling basin-flip bucket operating at sweepout flows

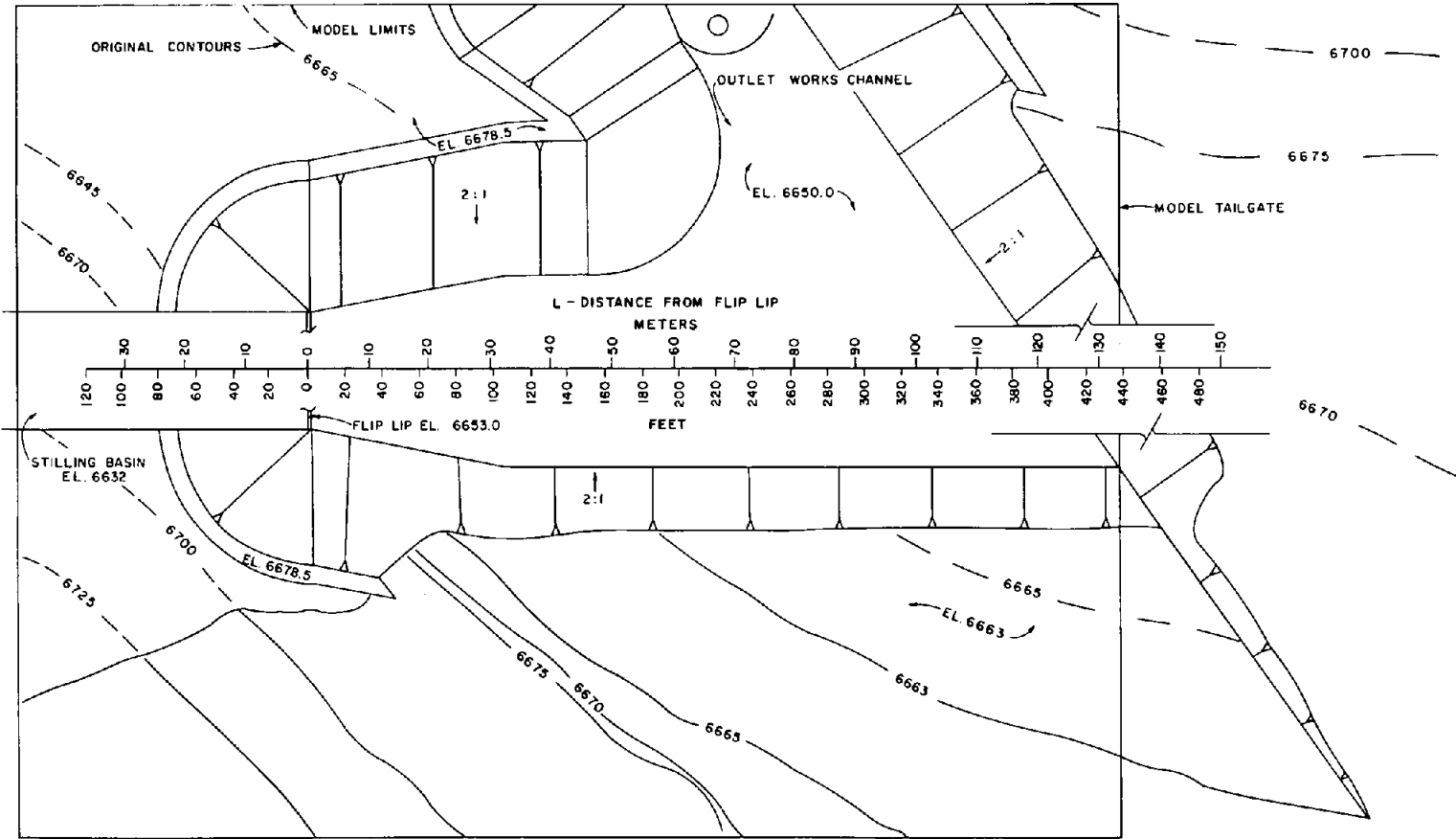

47

Notes:

1. All dimensions in prototype feet
2. All elevations in feet above mean sea level

Figure 25.—Plan of recommended exit channel



a. Debris placed in basin before stilling basin debris tests. Downstream view. Photo P801-D-79477

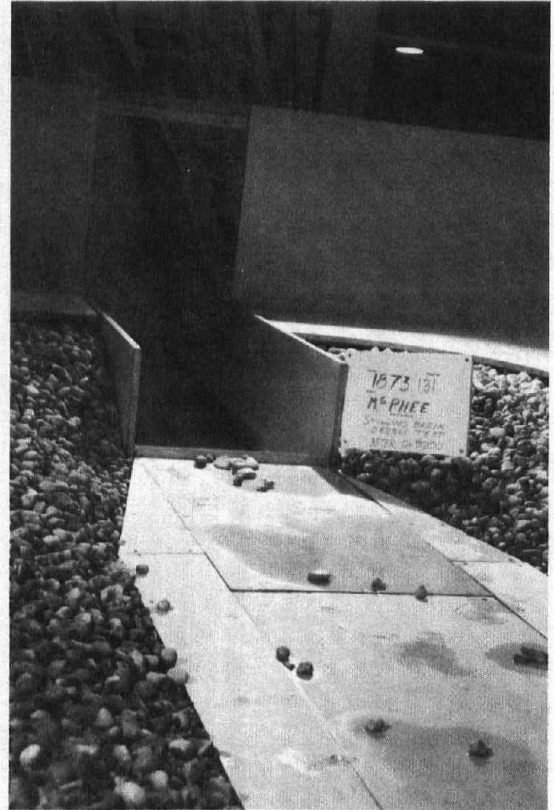

b. Location of debris after 45 minutes of model operation at $Q = 140 \text{ m}^3/\text{s}$ ($5000 \text{ ft}^3/\text{s}$) (4.5 hours prototype time). Downstream view. Photo P801-D-79478

Figure 26.-Stilling basin debris tests. Sheet 1 of 2.



United States Department of the Interior
BUREAU OF RECLAMATION

ENGINEERING AND RESEARCH CENTER

P O BOX 25007

BUILDING 67, DENVER FEDERAL CENTER

DENVER, COLORADO 80225

September 1, 1981

IN REPLY
REFER TO:

Memorandum

To: Recipients of GR-81-2

From: Chief, Technical Publications Branch

Subject: Correction to GR-81-2, Hydraulic Model Studies of McPhee Dam
Spillway

The following correction should be noted and made to figure 26 located
on pages 48 and 49:

- (1) Transpose photographs a and c.
- (2) Transpose photographs b and d.

Sorry for this inconvenience.

Warren F. Focht

King, Code 1530



c. Location of debris after 45 minutes model operation at $Q = 200 \text{ m}^3/\text{s}$ ($7000 \text{ ft}^3/\text{s}$). Note 75-mm rocks washed out and deposited downstream from the center of the flip lip. Photo P801-D-79479

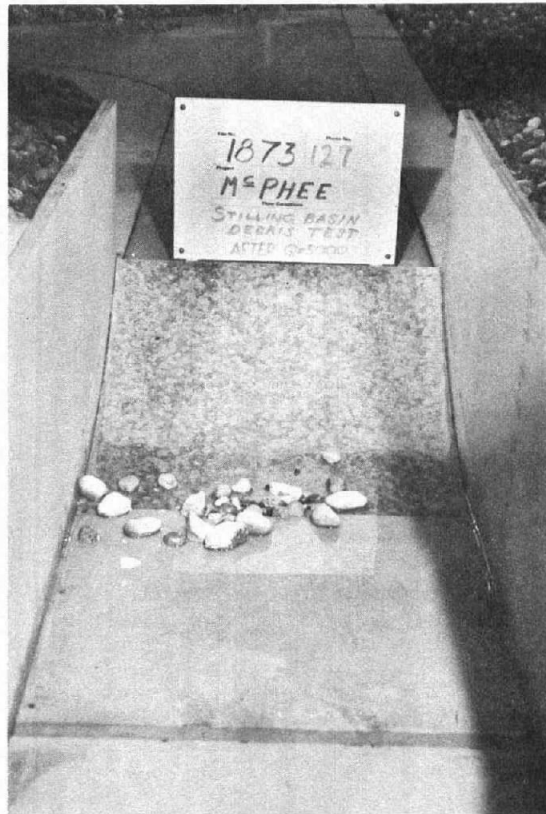

d. Location of debris after 45 minutes of model operation at $Q = 255 \text{ m}^3/\text{s}$ ($9000 \text{ ft}^3/\text{s}$). Most of the debris washed out and deposited in downstream channel. Photo P801-D-79480

Figure 26.-Stilling basin debris tests. Sheet 2 of 2.